

PrentaLux

Product Selection Guide
2026



2" Cylinders

Product Selection Guide

A summarized guide of the features and benefits of the PrentaLux 2 Inch integral LED Cylinders series.

Key Features

- Integral LED
- 4 CCTs: 2700K, 3000K, 3500K, 4000K
- CRI: 90
- Lumens ranging from 1000 lms to 2,000 lms
- Dimming: 0-10V and ELV Reverse Phase, 100-5% dimming.
- Voltage: 120-277V



Declare.



Housing Textures

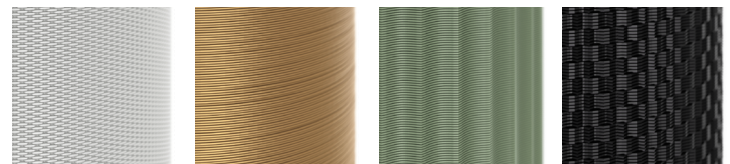

MW - Micro Woven

NL - Natural Lines

VF - Vertical Fluted

CH - Checkered

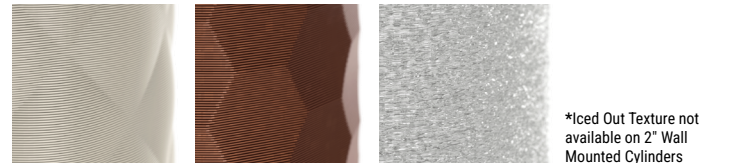

QS - Quilted Square

HC - Honeycomb

IC - Iced Out*

*Iced Out Texture not available on 2" Wall Mounted Cylinders

Standard Housing Colors



Trim Colors

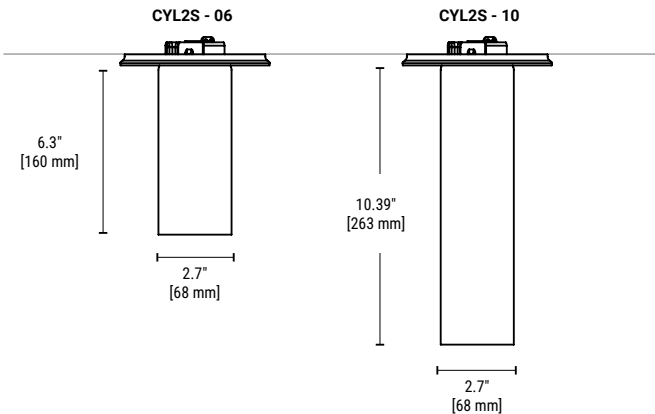
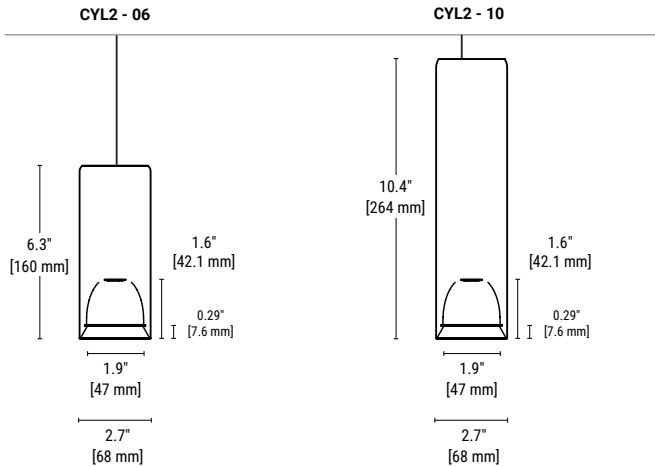

CYL2W - 10

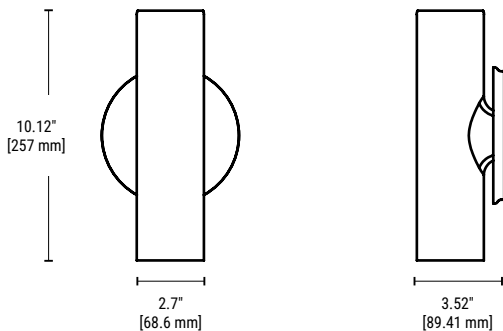

CYL2W - 06

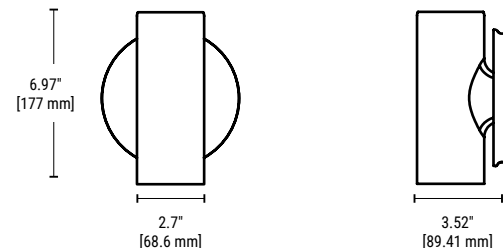

3" & 6" Cylinders

Product Selection Guide

A summarized guide of the features and benefits of the PrentaLux Cylinders integral LED series.

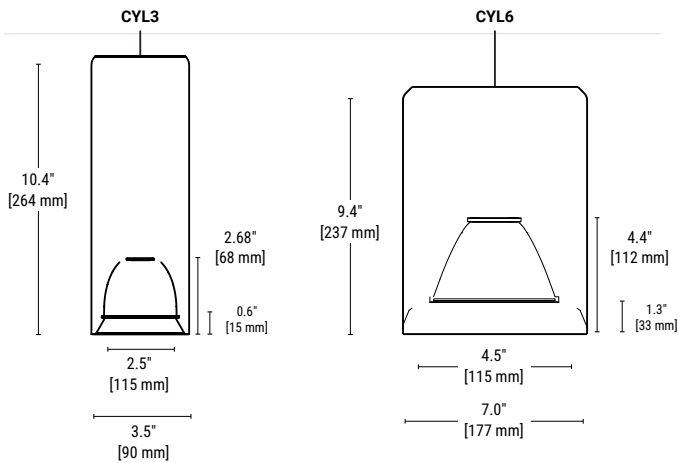

Key Features

- Integral LED
- 4 CCTs: 2700K, 3000K, 3500K, 4000K
- CRI: 90
- Lumens for CYL3: 1000-2300
- Lumens for CYL6: 1000-7000+
- Dimming: 0-10V, 1%
- Voltage: 120-277V



Housing Textures

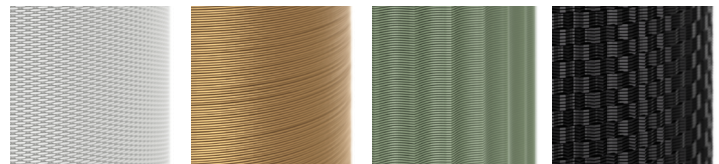

MW - Micro Woven

NL - Natural Lines

VF - Vertical Fluted

CH - Checkered

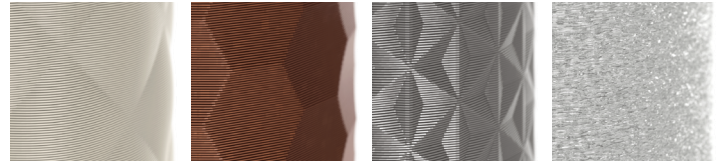

QS - Quilted Square

HC - Honeycomb

TP - Triangular Pyramids

IC - Iced Out

Standard Housing Colors

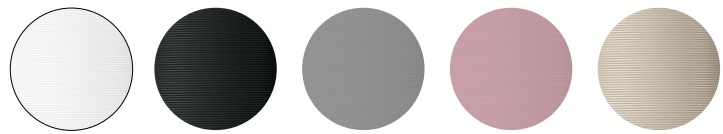

WHITE - White

BLAK - Black

GRAY - Gray

ROSE - Rose

CAPP - Cappuccino



SAGE - Sage

BRNZ - Bronze

BRSS - Brass

SLVR - Silver

Trim Colors



WHITE - White

BLAK - Black

BRNZ - Bronze

BRSS - Brass

SLVR - Silver

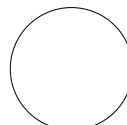

HTCM - Housing Trim Color Match

Cylinders in Scale

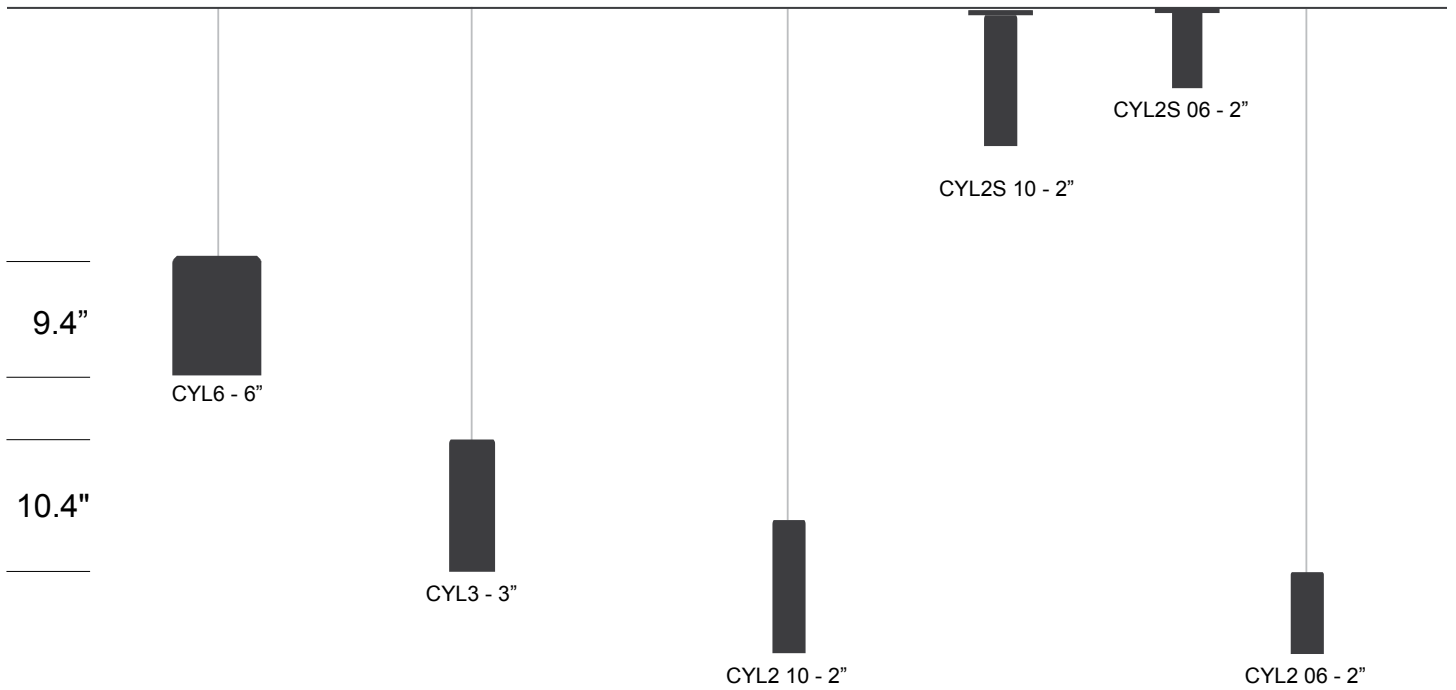

Key Features

- Integral LED
- 4 CCTs: 2700K, 3000K, 3500K, 4000K
- CRI: 90
- Lumens: 150-2700+
- Dimming: 0-10V, 1%
- Voltage: 120-277V



Minaro & Unaro Shade Textures

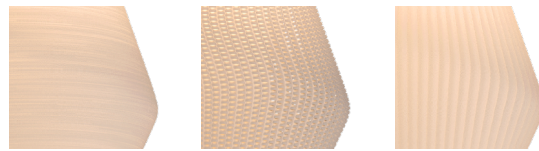

NL - Natural Lines

OW - Open Weave

PS - Pinstripe

Nimbaro Shade Textures



LF - Layered Fine

NL - Natural Lines

NR - Natural Ribs

WO - Woven Oval

Shade Color



TRWH - Translucent White

Standard Finial and Canopy Colors



WHITE - White



BLAK - Black



GRAY - Gray



ROSE - Rose



CAPP - Cappuccino



SAGE - Sage



BRNZ - Bronze

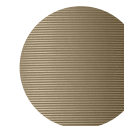

BRSS - Brass

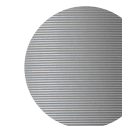

SLVR - Silver

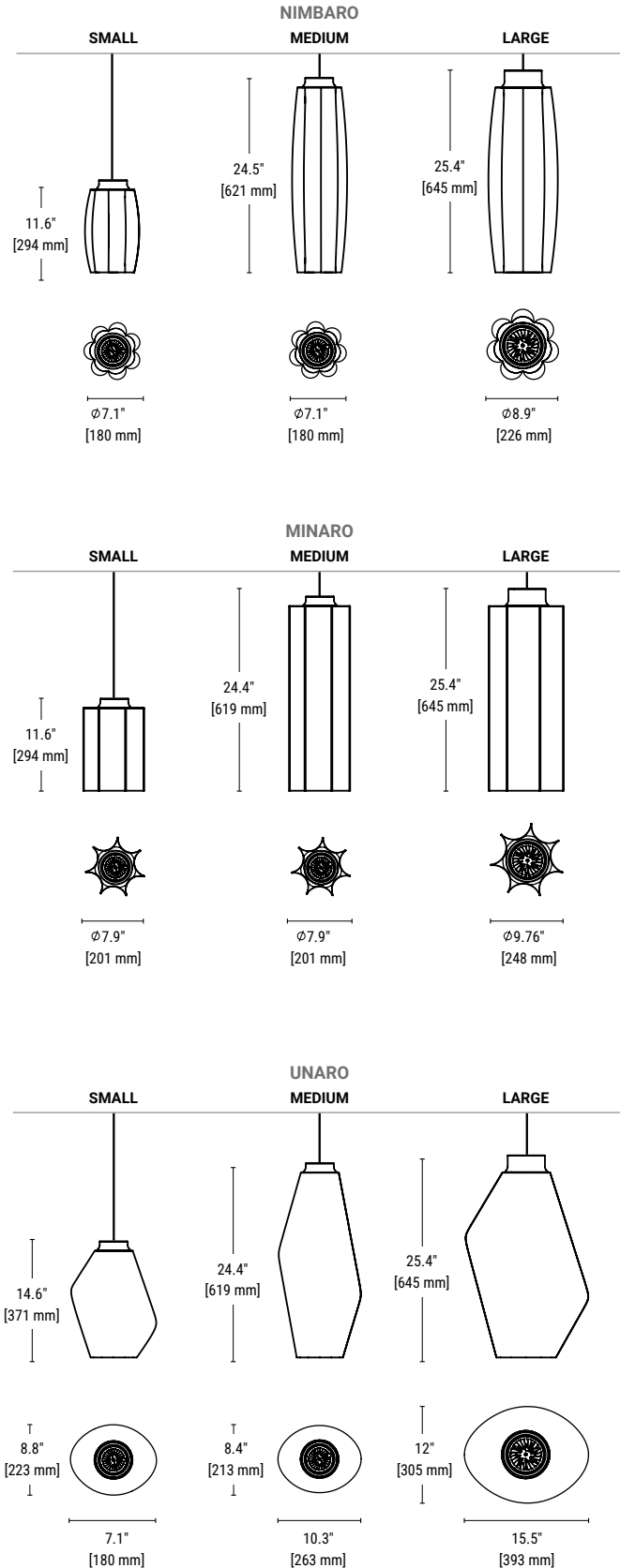

ARO in Scale

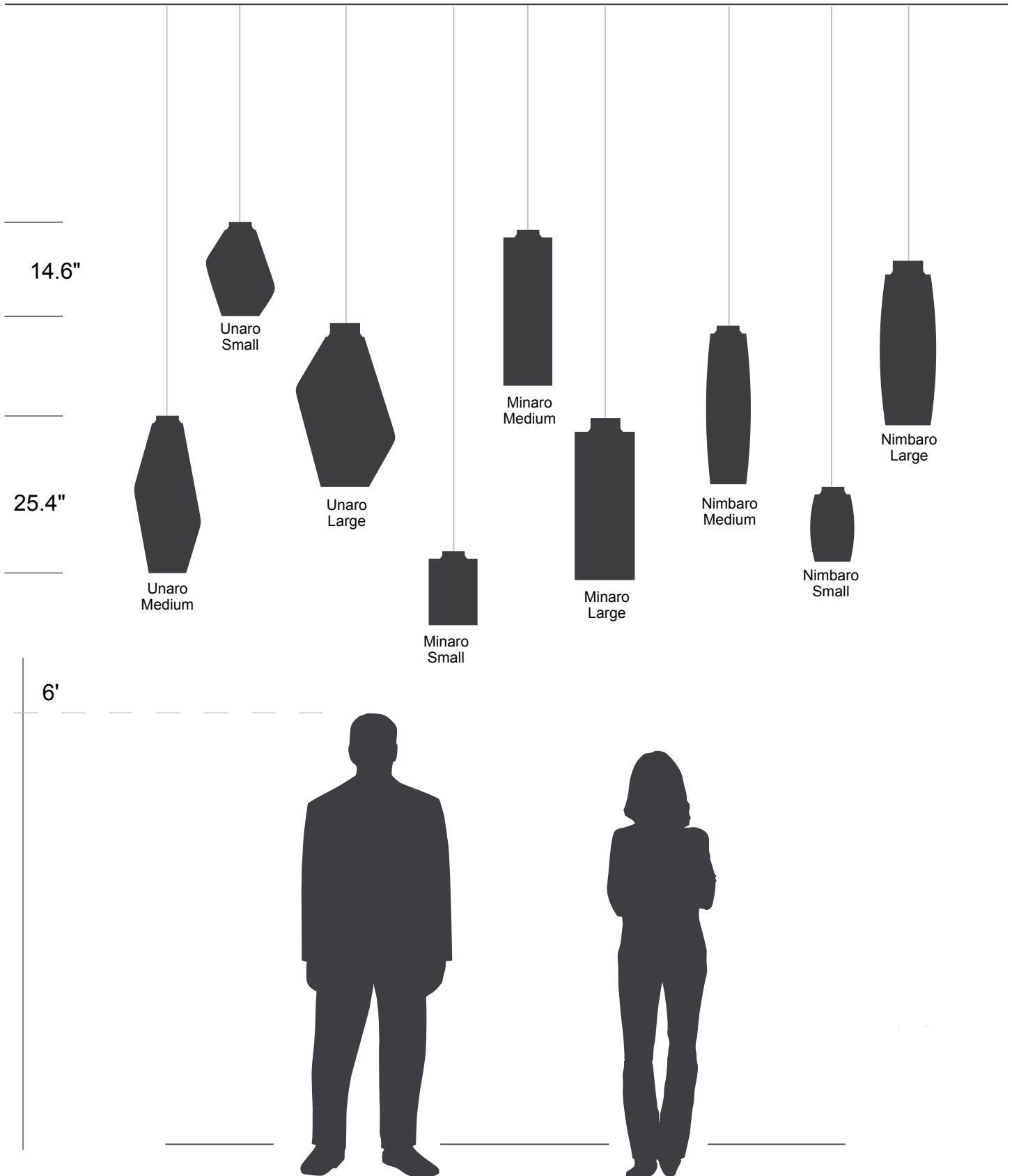

200s Double Shades

Product Selection Guide

A summarized guide of the features and benefits of the PrentaLux 200s Double Shade integral LED series.

Key Features

- Integral LED
- Lumens: 1000-9000+
- 4 CCTs: 2700K, 3000K, 3500K, 4000K
- CRI: 90
- Dimming: 0-10V, 1%
- Voltage: 120-277V



LIVING BUILDING CHALLENGE

3 Outer Shade Textures



LF - Layered Fine



VF - Vertical Fine



NF - Natural Lines

3 Inner Shade Textures

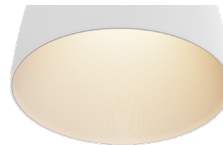

SR - Smooth

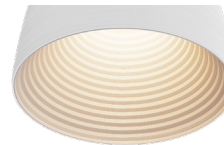

BR - Baffle



FL - Floral

Standard Opaque Outer Shade Colors



WHITE - White



BLAK - Black



GRAY - Gray

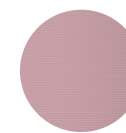

ROSE - Rose

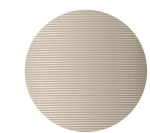

CAPP - Cappuccino



SAGE - Sage

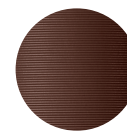

BRNZ - Bronze

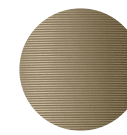

BRSS - Brass

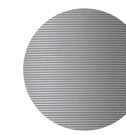

SLVR - Silver

Standard Inner Shade Colors



WHHR - White High Performance Reflective White



BRNZ - Bronze

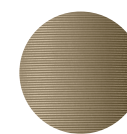

BRSS - Brass

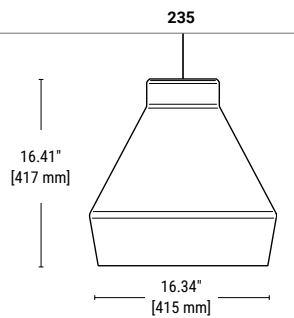
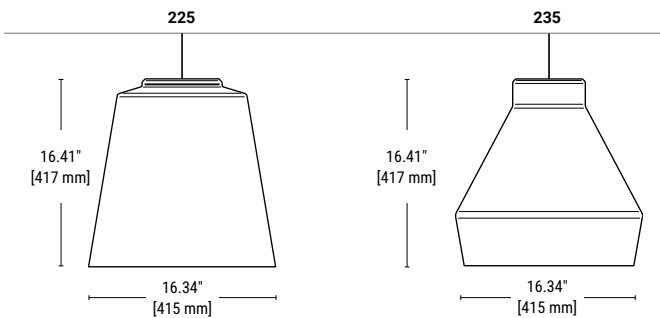
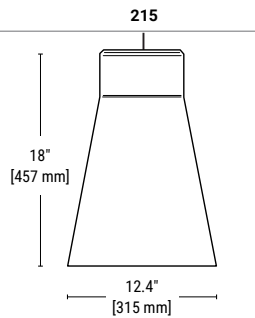
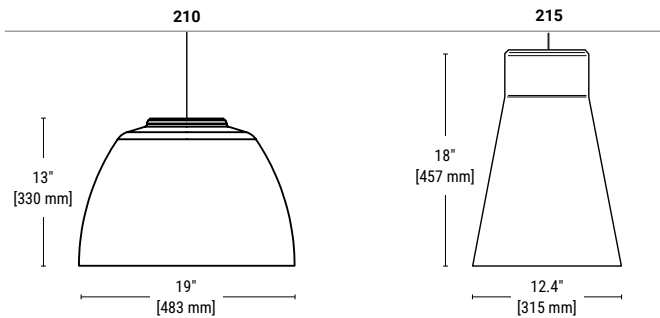
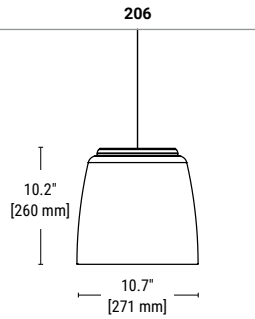
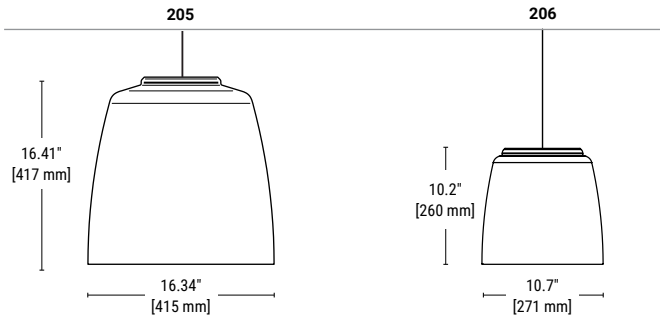

200s Single Shades

Product Selection Guide

A summarized guide of the features and benefits of the PrentaLux 200s Single Shade integral LED series.

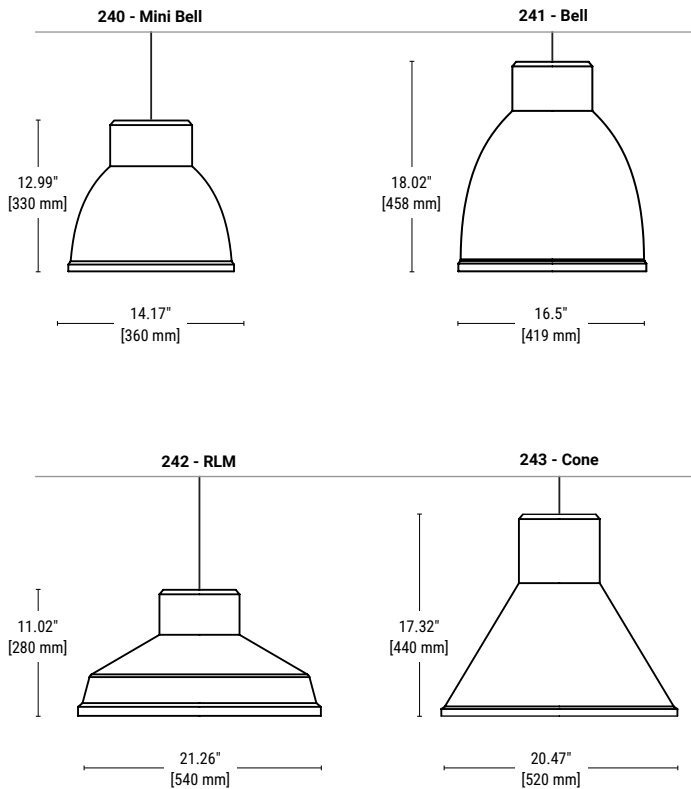

Key Features

- Integral LED
- Lumens: 1000-7000+
- 4 CCTs: 2700K, 3000K, 3500K, 4000K
- CRI: 90
- Dimming: 0-10V, 1%
- Voltage: 120-277V



Declare.



LIVING BUILDING CHALLENGE

3 Shade Textures



LF - Layered Fine

NL - Natural Lines

PNS - Pinstripe

Note:
 CLER (Clear) and SMGY (Smokey Gray) only available with PNS (Pinstripe Texture). Available as standard option on 240 and 241 only

Standard Transparent/Translucent Shade Colors

Available as standard option on 240 and 241 only

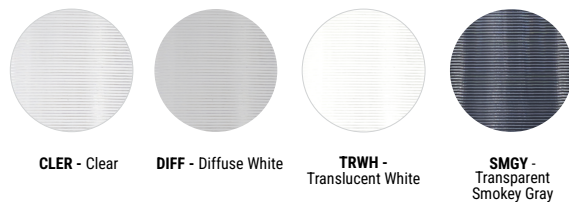

CLER - Clear

DIFF - Diffuse White

TRWH - Translucent White

SMGY - Transparent Smokey Gray

Standard Opaque Outer Shade Colors

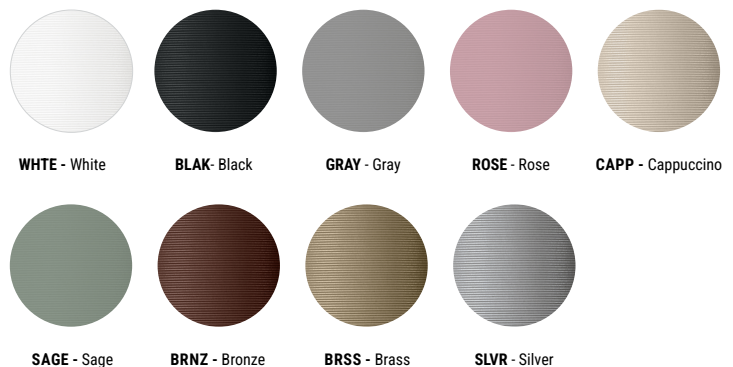

WHITE - White

BLAK - Black

GRAY - Gray

ROSE - Rose

CAPP - Cappuccino

SAGE - Sage

BRNZ - Bronze

BRSS - Brass

SLVR - Silver

200s in Scale

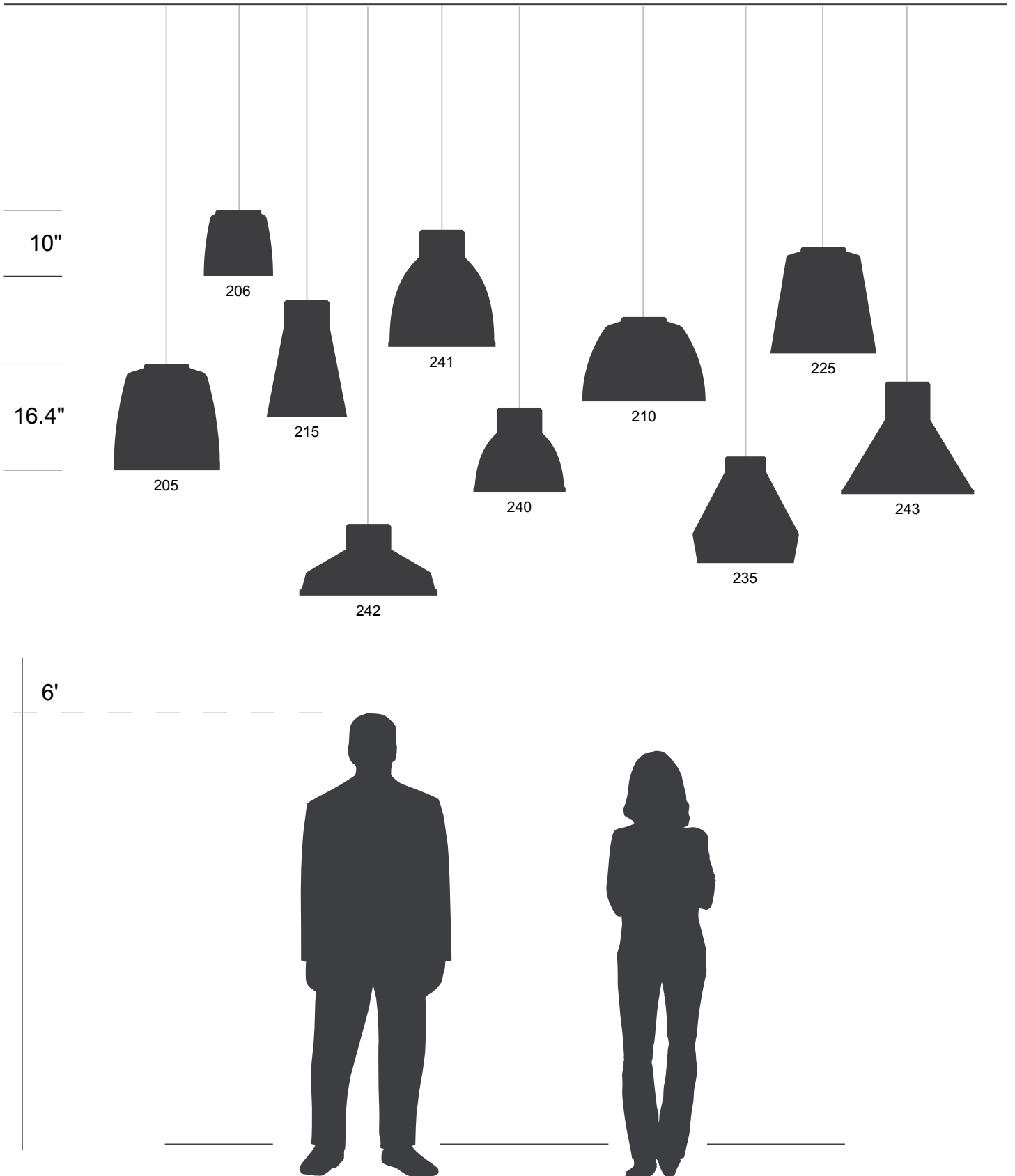

2000s

Product Selection Guide

A summarized guide of the features and benefits of the PrentaLux 2000s integral LED series.

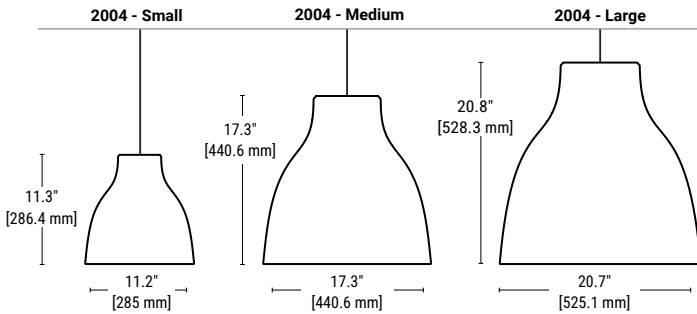
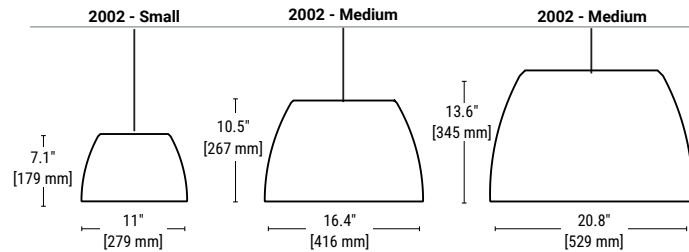
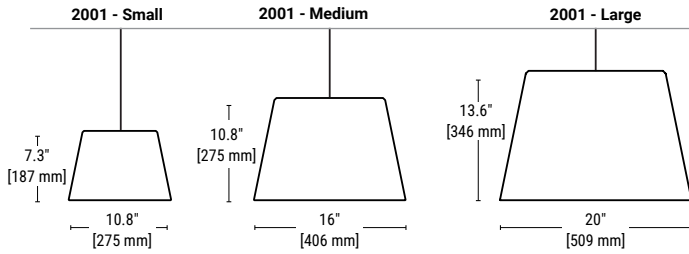

Key Features

- Integral LED
- 4 CCTs: 2700K, 3000K, 3500K, 4000K
- CRI: 90
- Lumens ranging from 500 lms to 13,000 lms
- Dimming: 0-10V, 1%
- Voltage: 120-277V



Declare.



LIVING BUILDING CHALLENGE

Diffuser Options

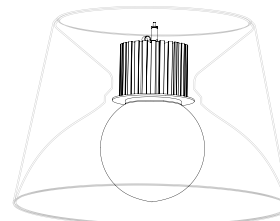

G - Globe Diffuser

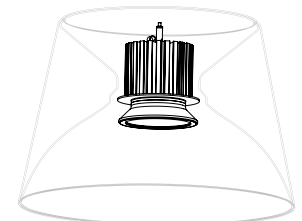

F - Flat Lens Diffuser

Standard Opaque Outer Shade Colors



WHITE - White

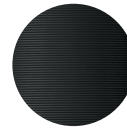

BLAK - Black

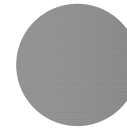

GRAY - Gray

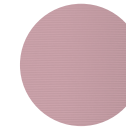

ROSE - Rose

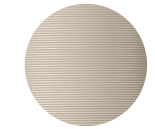

CAPP - Cappuccino



SAGE - Sage

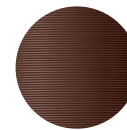

BRNZ - Bronze

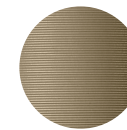

BRSS - Brass

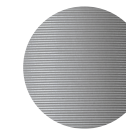

SLVR - Silver

Standard Inner Shade Colors



WHHR - White High Performance Reflective White

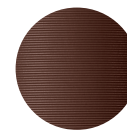

BRNZ - Bronze

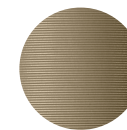

BRSS - Brass

2000s in Scale



300s

Product Selection Guide

A summarized guide of the features and benefits of the PrentaLux 300s LED lamp based series.

Key Features

- Lamp Options:
 - A-19, Frosted 3000K LED lamp
 - 2700K Filament Lamp
 - No lamp (lamp by others)
- Modern forms available in 9 standard opaque colors and 4 standard transparent/translucent colors. On-Demand colors available with possible additional costs and lead times.



Declare.



LIVING BUILDING CHALLENGE

Standard Transparent/Translucent Shade Colors Not Available for Top Finial



CLR - Clear



DIFF - Diffuse White



TRWH - Translucent White

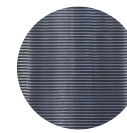

SMGY - Transparent Smokey Gray

Standard Opaque Shade & Top Finial Colors



WHITE - White



BLAK - Black

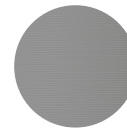

GRAY - Gray

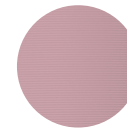

ROSE - Rose



CAPP - Cappuccino

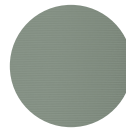

SAGE - Sage

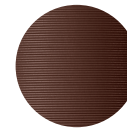

BRNZ - Bronze

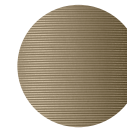

BRSS - Brass

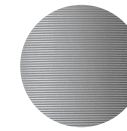

SLVR - Silver

Finial Color Recommendations

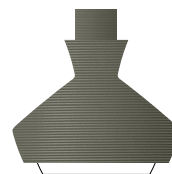

TFIN -
Top Finial Color
Same as Outer
Shade Color

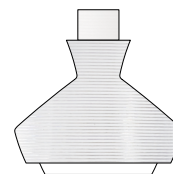

TFWHT - White
(if CLR Outer Shade Color
option chosen, White top
finial is recommended)



TFBKMT - Black
(if SMGY Outer Shade
Color option chosen,
Black top finial is
recommended)

400s

Product Selection Guide

A summarized guide of the features and benefits of the PrentaLux 400s LED lamp based series.

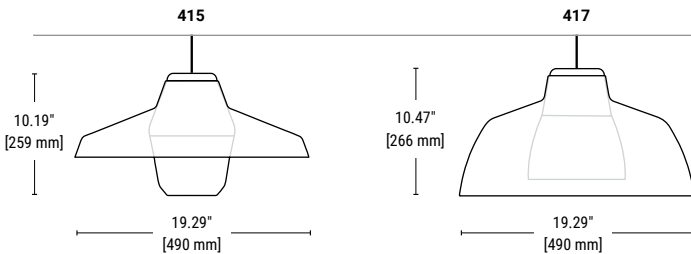
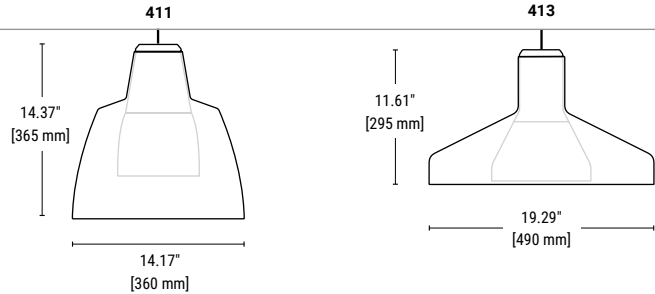
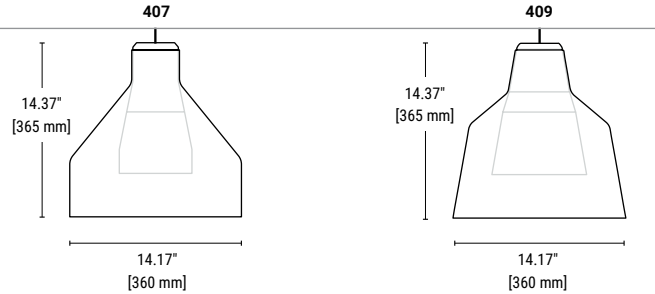
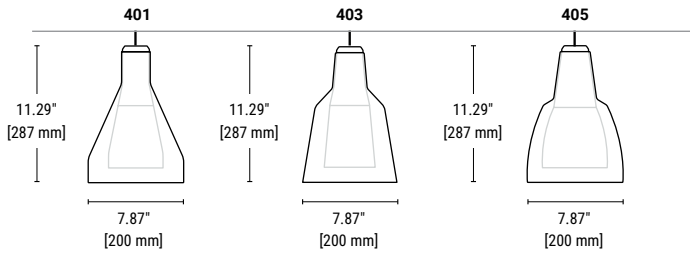

Key Features

- Lamp Options:
 - A-19, Frosted 3000K LED lamp
 - 2700K Filament Lamp
 - No lamp (lamp by others)
- Modern forms available in 9 standard opaque colors and 4 standard transparent/translucent colors. On-Demand colors available with possible additional costs and lead times.



Declare.



LIVING BUILDING CHALLENGE

6 Outer Shade Textures

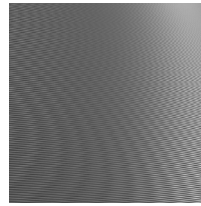

RHL - Refined Horizontal Lines

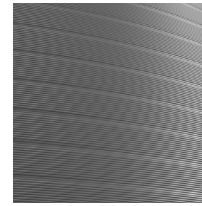

GHL - Grooved Horizontal Lines

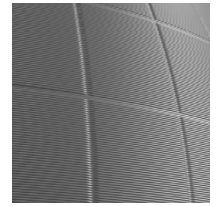

GRD - Grid

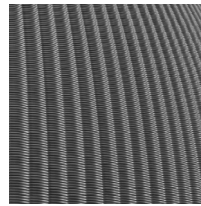

PNS - Pinstripe

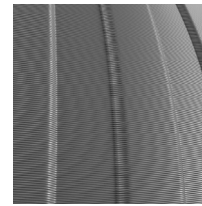

DVL - Deep Vertical Lines

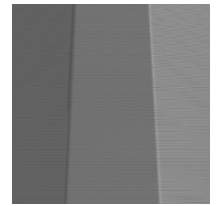

FAC - Facets

Standard Transparent/Translucent Shade Colors Not Available for Top Finial



CLER - Clear



DIFF - Diffuse White



TRWH - Translucent White

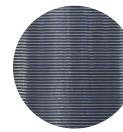

SMGY - Transparent Smokey Gray

Standard Opaque Shade & Top Finial Colors



WHITE - White



BLAK - Black



GRAY - Gray

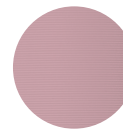

ROSE - Rose



CAPP - Cappuccino



SAGE - Sage

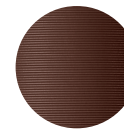

BRNZ - Bronze

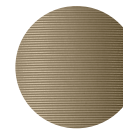

BRSS - Brass

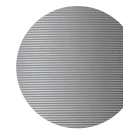

SLVR - Silver

300s & 400s in Scale

