

Project		Catalog #		Type	
Prepared by		Notes		Date	

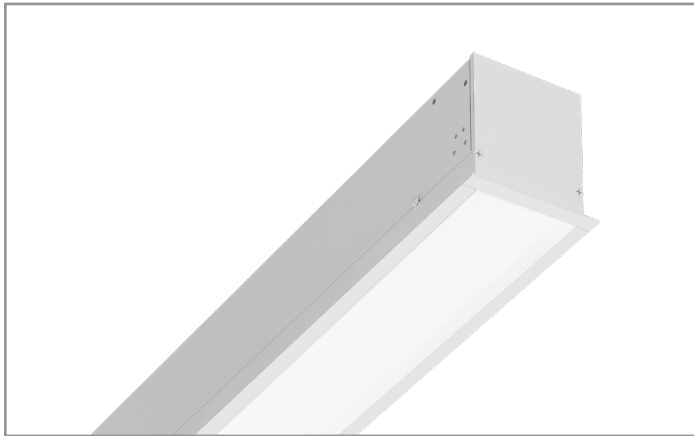

Neoray

Define | Recessed | 4in

Direct Only

Typical Applications

Education • Healthcare • Hospitality • Office • Retail • Transit

Interactive Menu

- Order Information page 2
- Photometric Data page 7
- Energy and Performance Data page 8
- Control Solutions page 12
- Product Limited Warranty



Top Product Features

- Define Recessed family available in 2in, 3in, 4in, and 5in
- Multiple Optic options
- Continuously illuminated straight runs, corners, intersections, and patterns
- Wired and wireless controls
- VividTune and BioUp Technology

Dimensions

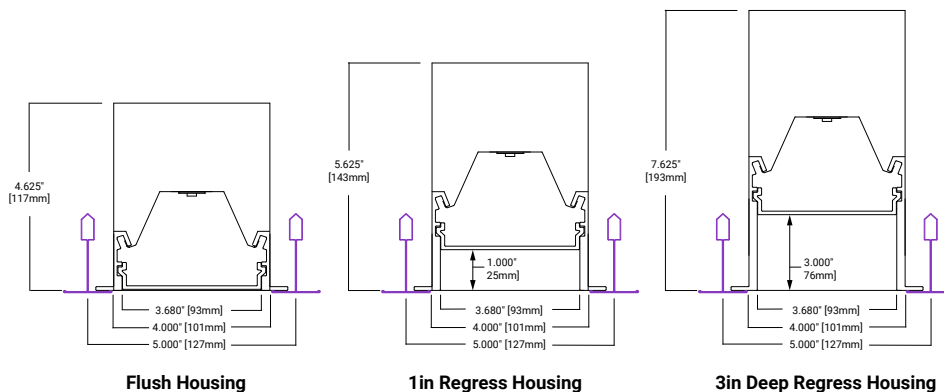

Order Information

Icon Key: Grey bar denotes available with 10-Day Quick Spec

SAMPLE ORDER NUMBER: S124DR-S500D935-FES24F0-1-UDD-F-BM-P

Domestic Preference‡	Delivery	Body			Output
		Series	Optic Compatibility	Direction & Location	Performance
[Blank] = Standard BAA = Buy American Act‡ BABA = Build America Buy American Act‡	[Blank] = None QS = QuickSpec	S124 = Define 4	[Blank] = Flush Housing R = 1in Regress Housing R3 = 3in Deep Regress Housing <i>Coming Soon!</i>	DR = Direct Only Recessed	S = Standard H = High Performance V = VividTune B = BioUp
Notes ‡Only product configurations with these prefixes are built to be compliant with the Buy American Act of 1933 (BAA) or the Build America Buy America Act (BABA). BABA is the minimum Government compliance requirement for the Build America Buy America standards which is part of the Infrastructure and Investment Jobs Act (IIJA). Individual Government Agencies may have more stringent compliance standards. Please refer to the DOMESTIC PREFERENCES website or consult the CLS Domestic Preferences team for more information. Components shipped separately may be separately analyzed under domestic preference requirements.	Notes Grey bar denotes option available with 10-Day QuickSpec	Notes	Notes Use 1in Regress compatible body for 1in Regress optic with Frosted Lens (F) and Louvers (VL) only. Use 3in Deep Regress compatible body for 3in Regress optic with Frosted Lens (F) only.	Notes	

Output (Cont'd)				Mounting	Pattern Length	
Direct Output	CRI	CCT		Ceiling Type	Length	Max Section Length
350D = 350 Lm/ft Direct 575D = 575 Lm/ft Direct 795D = 795 Lm/ft Direct 1020D = 1020 Lm/ft Direct 1195D = 1195 Lm/ft Direct _D = Custom Lm/ft Direct	8 = 80 CRI 9 = 90 CRI B = BioUp	Static 27 = 2700K 30 = 3000K 35 = 3500K 40 = 4000K 50 = 5000K	VividTune 2765 = 2600-6500K 3050 = 3000-5000K BioUp Dynamic 2750 = 2700-5000K	Grid Ceiling ETG = 15/16in Flat T-Grid ETT = 15/16in Flat T-Grid with Tegular Tiles FTG = 9/16in Flat T-Grid FTT = 9/16in Flat T-Grid with Tegular Tiles STG = 9/16in Slotted Dimensional T-Grid ITG = 9/16in Interlude Dimensional T-Grid Hard Ceiling GYP = Visible Flange FSR = Flangeless (Mud-in) Other Ceiling Systems FES = Finished Extruded Side (Wood Slat, Wood Panel, Fabric, Metal, etc)	2F0 = 2ft 3F0 = 3ft 4F0 = 4ft 5F0 = 5ft 6F0 = 6ft 7F0 = 7ft 8F0 = 8ft 9F0 = 9ft 10F0 = 10ft 11F0 = 11ft 12F0 = 12ft _F_ = Specify Length	[Blank] = Standard /8 = 8ft Max Section Length
Notes Specify Lumen Output to the nearest 10Lm/ft: Min = 350Lm/ft Max = 1,195Lm/ft Performance is based on 3500K 80CRI with Flush Frosted Lens and White housing. Reference Lumen Adjustment Factors table for more detail. Reference BioUp (B) section for output availability.	Notes VividTune (V) available with 90CRI 2600-6500K (92765) and 3000-5000K (93050) only. BioUp Static available with 3500K (B35), 4000K (B40), and 5000K (B50) only. BioUp Dynamic available with 2700-5000K (B2750) only. Reference BioUp (B) section for correlated CRI values.		Notes	Notes Specify individual luminaire, linear run, or total custom pattern lengths in xft/xin increments (ex. 37F10 = 37ft 10in). Please include the angle for each illuminated corner and intersection when providing sketch/drawing (ex. A045 = 45°). Min fixture length is 2ft. Nominal lengths. Reference drawings for total length (including end caps and flanges). Reference BioUp section for minimum length available with BioUp (B).	Notes Use [Blank] to allow for up to 12ft individual luminaires. Use 8ft Max Section Length (/8) to limit max individual, run, and pattern section lengths to 8ft.	

Electrical Wiring		Electrical		Optics
Circuiting	Emergency Options	Voltage	Wired Controls	Direct Optics
1 = Single Circuit S = Secondary Circuit	[Blank] = None E = Emergency Circuit B1 = 7W External Battery B2 = 14W 7W External Battery B3 = 6W External Battery T = UL924 Bypass Relay Device	U = Universal (120V-277V) 1 = 120V 2 = 277V 3 = 347V	DD = Standard 0-10V (1%-100%) Other 5L = Fifth Light DALI (5%-100%) LH = Lutron EcoSystem DALI (1%-100%) For use with VividTune W2A = 2-Channel 0-10V For use with Dynamic BioUp W2A = 2-Channel 0-10V W2D = 2-Channel DALI	[Blank] = N/A F = Frosted Lens (Diffuse) D = Frosted 1in Drop Lens (Diffuse) A = Asymmetric WVL = White Louver w/ Frosted Lens SVL = Silver Louver w/ Frosted Lens BVL = Black Louver w/ Frosted Lens
Notes Secondary Circuit (S) allows A/B switching within a run or Pattern (P).	Notes Battery and UL924 Bypass Relay Device are available with 120V-277V (U, 1, or 2) only. Battery (B1 and B2) options available with 0-10V (DD or W2A) and single channel DALI (5L or LH) Controls options only. Reference Emergency Options product specification notes and Battery Location tables for additional details.	Notes 347V (3) available with Standard 0-10V (DD) Controls option only	Notes Use Standard 0-10V (DD) for Static BioUp (B). 2-Channel 0-10V (W2A) available with VividTune (V) and Dynamic BioUp (B2750) only. 2-Channel DALI (W2D) available with Dynamic BioUp (B2750) only. Fifth Light DALI (5L) available with 1% dimming upon request.*	Notes Use [Blank] with Indirect Only Luminaire Louvers (VL) available with 1in Regress (R) compatible housing in 1ft increments only. Louvers (VL) available in <1ft increments and custom Pattern (P) by request.* Asymmetric (A) available with VividTune upon request.* Performance is based on 3500K 80CRI with Flush Frosted Lens and White housing. Reference Lumen Adjustment Factors table for more detail.

*Note: Options listed as "available by request" require review and may impact pricing and leadtime.

Order Information

Icon Key: Grey bar denotes available with 10-Day Quick Spec

SAMPLE ORDER NUMBER: S123DR-S500D935-FES24F0-1-UDD-F-BM-P

Electrical Options	Options Body Finish	Wireless Controls	Pattern Type	Special Options*
<p>[Blank] = None CP = Chicago Plenum</p>	<p>W = White S = Silver B = Black (Semi-Gloss) BM = Black (Matte)</p> <p>RR = Real Red OO = Oasis Orange YY = Yippee Yellow GG = Gracious Green CC = Cyprus Cyan TT = Totally Turquoise BB = Biosphere Blue PP = Perfect Purple VV = Vacation Violet MM = Magic Magenta</p> <p>C = Custom Color (RAL) CM = Custom Color (Match)</p>	<p>[Blank] = None</p> <p>Wavelinx Wireless WPS = WaveLinX PRO Integrated Sensor WLS = WaveLinX LITE Integrated Sensor WPST = WaveLinX PRO Tilemount Sensor WLST = WaveLinX LITE Tilemount Sensor</p>	<p>[Blank] = Individual or Straight Run P = Pattern</p>	<p>[Blank] = None FC = Field Cuttable End* FE = Field Extendable End* SHRD = Shallow Housing w/ Remote Driver* MRI = MRI Room w/ Remote Driver*</p>
<p>Notes Reference Battery Location tables for Chicago Plenum (CP) with Battery.</p>	<p>Notes Custom Colors (C and CM) are available by request.* Performance is based off White (W) and may vary with selected finish.</p>	<p>Notes WaveLinX is available with (DD) and Single Circuit (1) only. Integrated Sensors with Louvers, Regressed, or Drop lenses available by request.* Integrated Sensors combined with Emergency Circuit (E) require one UL924 Bypass Relay (T) per emergency fixture.</p>	<p>Notes Please include the angle for each illuminated corner and intersection when providing sketch/drawing (ex. A045 = 45°) for a custom Pattern (P).</p>	<p>Notes *All special options available by request.* Multiple Special Option Codes may be specified with a "-" to separate. (ex. XX-YY-ZZ) Field Cuttable End (FC) extends the end-of-run housing 4in beyond the requested length providing an unlit field cuttable section. Field Extendable End (FE) allows for extension of the end-of-run housing 4in beyond the requested length with an extendable rear housing cover. Shallow Housing with Remote Driver (SHRD) reduces the housing height by including a remote driver housing solution. MRI Room with Remote Driver (MRI) provides a non-ferrous housing solution and includes a remote driver housing solution.</p>

*Note: Options listed as "available by request" require review and may impact pricing and leadtime.

Product Specifications

Domestic Preference‡

- ‡Only product configurations with these prefixes are built to be compliant with the Buy American Act of 1933 (BAA) or the Build America Buy America Act (BABA). BABA is the minimum Government compliance requirement for the Build America Buy America standards which is part of the Infrastructure and Investment Jobs Act (IIJA). Individual Government Agencies may have more stringent compliance standards. Please refer to the [DOMESTIC PREFERENCES](#) website or consult the CLS Domestic Preferences team for more information. Components shipped separately may be separately analyzed under domestic preference requirements.

Serviceability

- Snap-in lens allows easy access to optical cavity and light engine.
- Removable modular light engine tray with quick disconnect wire-harness for ease of installation and maintenance over the life of the luminaire

Construction

- Precision cut housing trim extruded from 6063 aluminum with aluminum frame
- Flush, 1in Regress, and 3in Deep Regress Housing options available

Individuals, Runs, Patterns

- Fully luminous individual luminaires, straight runs, or custom patterns
- Patterns constructed using precision mitered housing and lens components
- The frame is welded to ensure a precise and robust housing
- Specify individual luminaire, linear run, or total custom pattern lengths in xft/xin increments
- Minimum fixture length is 23in
- All lengths are nominal lengths and do not include end flanges; reference drawings for total lengths.
- Actual sizes are 1in shorter than nominal to account for easy on-center Grid Ceiling installation (ex. 4F0 for 47in length).
- Add 1in to overall fixture length for Hard Ceiling installation (ex. 4F1 for 48in length)
- 8ft Max Section Length used on straight runs and patterns; use 8ft Max Section Length to limit max individual, run, and pattern section lengths to 8ft

Output

- Specify Custom Lumen Output to the nearest 10Lm/ft
- Available in Static 2700K, 3000K, 3500K, 4000K, 5000K
- CRI ≥ 80 CRI or ≥ 90 CRI
- Nominal performance is based on 3500K 80CRI with Flush Frosted Lens and White Housing; reference Lumen Adjustment Factors table for more detail.
- Extrapolated LED lifetime per TM-21:
 - Greater than L90 at 61,000 hrs
 - L70 exceeding 100,000 hrs
- Available in 120-277V, 347V
- VividTune Tunable White available in Dynamic 2600K-6500K or 3000K-5000K; reference VividTune section for additional details
- BioUp Melanopic Lighting available in Static 3500K, 4000K, 5000K or Dynamic 2700K-5000K
- BioUp CRI ranges from >80 CRI to 96CRI
- Reference BioUp section for additional details including Melanopic Daylight Efficacy Ratio (MDER)

Optics

- Patented solution provides consistent illumination with no pixelation at the ends of individual luminaires, straight runs, and patterns.
- Direct Optics
 - F (or FLL): Frosted lens (Diffuse) with Lambertian distribution
 - D: Frosted 1in Drop Lens with Wide Lambertian distribution
 - A: Frosted lens with Asymmetric distribution
 - VL: Premium straight blade Louver with metal construction and Frosted lens. 1in regress with 1in spacing provides superior low glare 45° cutoff

Emergency Options

- Battery operates entire downlight portion of individual luminaires < 7 ft
- Battery operates 4ft sections of longer luminaires, runs, and patterns
- Reference Battery Location section for additional details
- UL924 Bypass Relay Device available as emergency generator transfer option
- Emergency Circuit combined with Integrated Sensors require one UL924 Bypass Relay per emergency fixture

Integrated Controls

- 0-10V dimming to 1% standard
- Fifth Light DALI dimming to 5% standard; Fifth Light DALI dimming to 1% available by request*
- Lutron EcoSystem DALI dimming to 1% standard
- Additional control types may be available by request*
- Reference Sensor Placement section for default integrated sensor locations of individual luminaires and straight runs
- Please include preferred integrated sensor locations when providing sketch/drawing for a custom Pattern (P)

Mounting

- Compatible with Multiple Grid Ceiling, Drywall Ceiling, and Other Ceiling Systems
- Reference Mounting section and installation instructions for additional details

Finish

- Electrostatically applied polyester powder coat paint
- See Finish Options section for additional details
- RAL Colors and Custom Match Colors available by request*

Special Options*

- *All special options available by request*
- *Any options listed as 'available by request' require review and may impact pricing and leadtime
- Consult factory to request any options not listed
- Reference the Mods Collection for common special option requests

Compliance

- UL listed for damp locations
- IC Rated for insulation contact (except where noted)
- RoHS
- Tested to IESNA LM-79 and LM-80
- Can be used for State of California Title 24 high efficacy luminaire
- DLC qualified options available

Warranty

- Five year limited warranty www.cooperlighting.com/legal

Finish Options

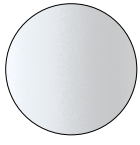

W - White

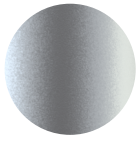

S - Silver



B - Black
Semi-Gloss



BM - Black
Matte



RR - Real Red
RAL 3020
Gloss



OO - Oasis Orange
RAL 2004
Gloss



YY - Yippee Yellow
RAL 1018
Gloss

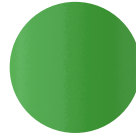

GG - Gracious Green
RAL 6018
Gloss



CC - Cyprus Cyan
RAL 6027
Gloss



TT - Totally Turquoise
RAL 5018
Gloss

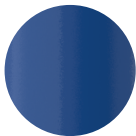

BB - Bioshere Blue
RAL 5017
Gloss



PP - Perfect Purple
RAL 4005
Gloss



VV - Vacation Violet
RAL 4008
Gloss



MM - Magic Magenta
RAL 4010
Gloss

RAL Colors & Custom Match Colors available by request*



Ceiling Type

Grid Ceiling

15/16 Tee (ETG)

15/16 Tegular (ETT)

Note: All lengths are nominal lengths and do not include end flanges; reference submittal drawings for total lengths.

Add 1in to ordered overall fixture length for Hard Ceiling installation (ex. 4F1 for 48in length)

Actual lengths are 1in shorter than nominal to account for easy on-center Grid Ceiling installation (ex. 4F0 for 47in length).

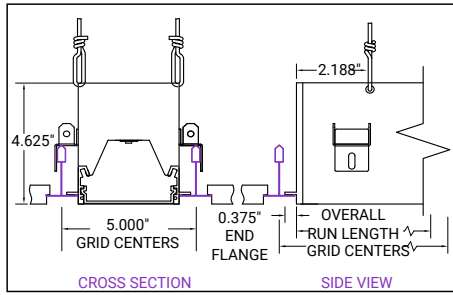
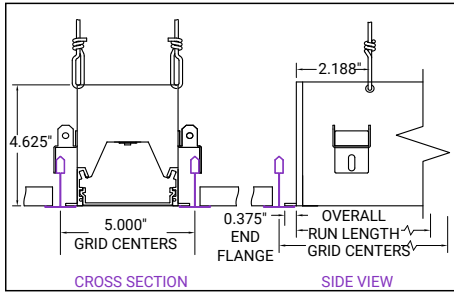

9/16 Tee (FTG)

9/16 Tegular (FTT)

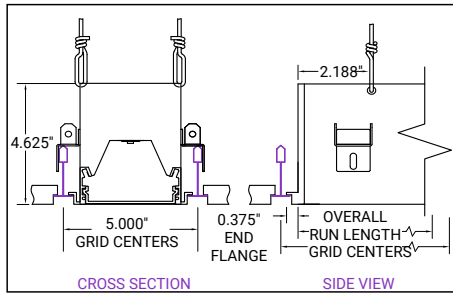
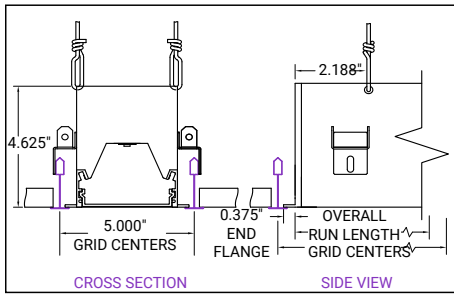

9/16 Slotted Tee (STG)

9/16 Interlude Tee (ITG)

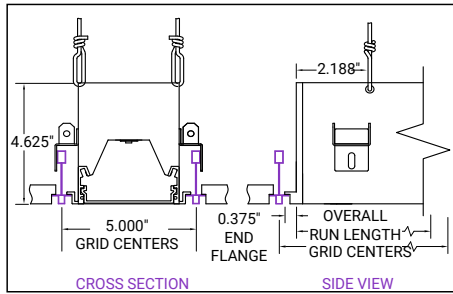
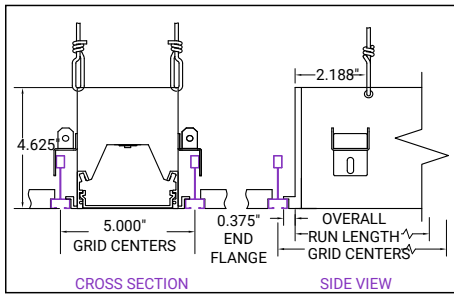

Hard Ceiling

Visible Flange (GYP)

Mud-In Flange (FSR)

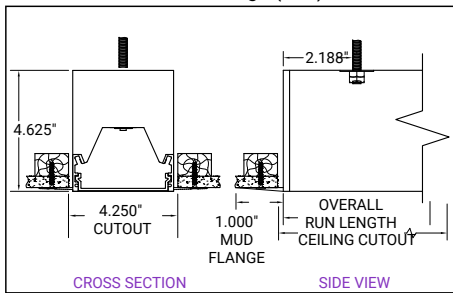
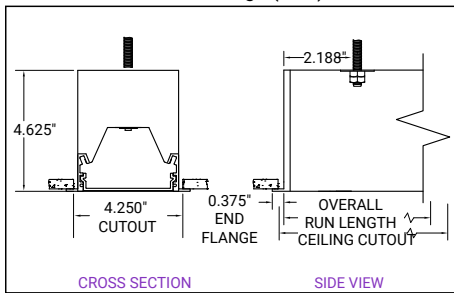

Other Ceiling Systems

Finished Extruded Side (FES)

Typical Installations using Finished Extruded Side (FES)

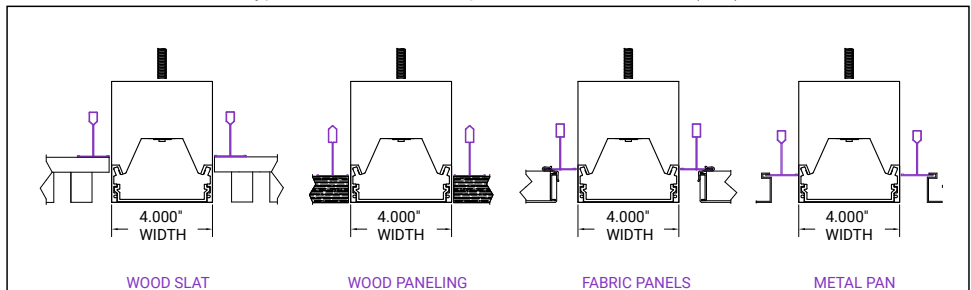
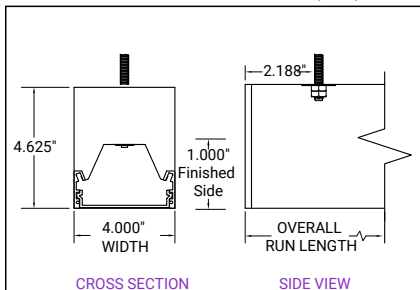

Photometric Data - Static White LED Technology

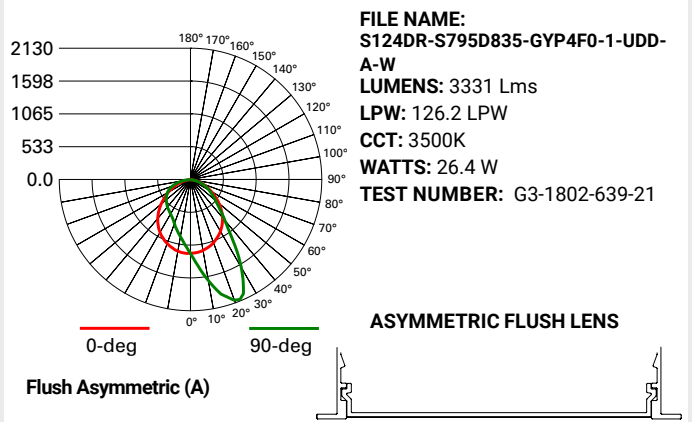
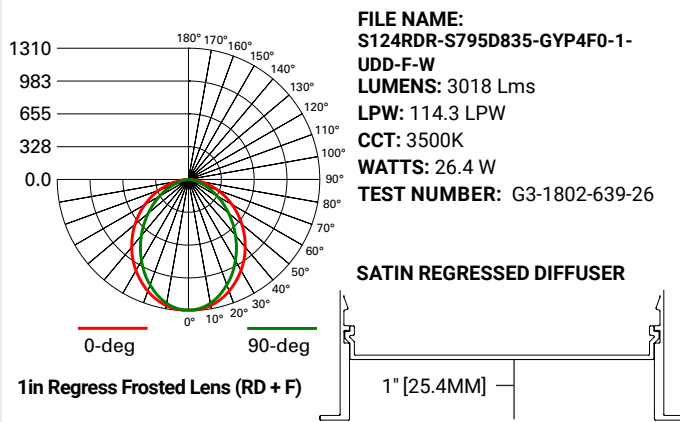
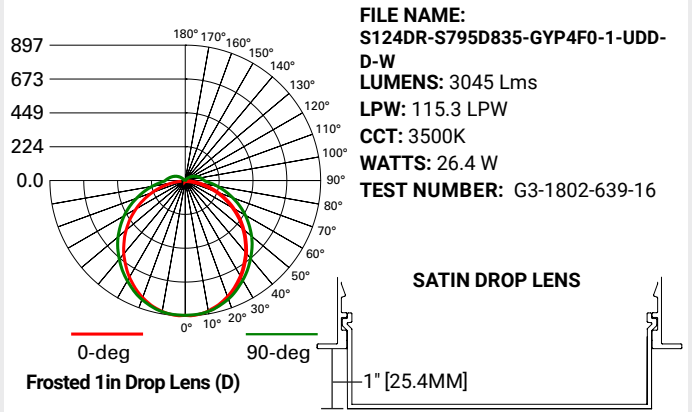
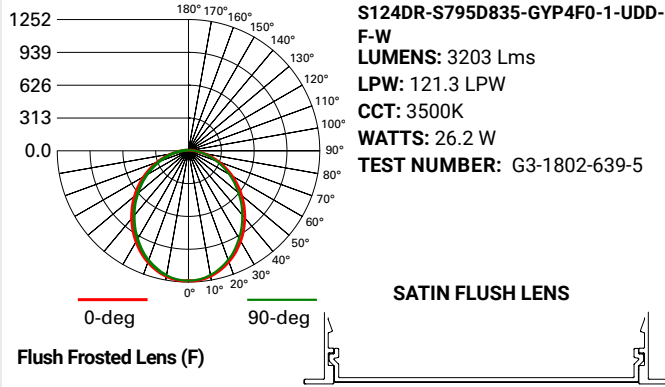

Photometric Overview and Performance Data

Direct Performance Per Linear Foot at 3500K/80CRI

Nominal Output	Standard		High Performance		VividTune	
	W/ft	lm/W	W/ft	lm/W	W/ft	lm/W
350	-	-	2.9	119	3.0	114
575	6.0	95.8	4.4	126	4.8	116
795	8.6	92.4	6.1	126	6.8	114
1020	11.5	88.7	8.1	123	8.9	111
1195	-	-	9.7	120	10.6	109

Lumen Adjustment Factors

Body Finish	Direct Optics	
White (W)	Flush Frosted Lens (F)	1.000
	Asymmetric (A)	1.040
	Drop (D)	0.950
	1in Regress Frosted (RD + F)	0.942
	White Louver w/ Frosted Lens (WVL)	0.609
	Silver Louver w/ Frosted Lens (SVL)	0.372
	Black Louver w/ Frosted Lens (BVL)	0.316
Silver (S)	White Louver w/ Frosted Lens (WVL)	0.510
	Silver Louver w/ Frosted Lens (SVL)	0.325
	Black Louver w/ Frosted Lens (BVL)	0.278
Black (B)	White Louver w/ Frosted Lens (WVL)	0.482
	Silver Louver w/ Frosted Lens (SVL)	0.307
	Black Louver w/ Frosted Lens (BVL)	0.265

CCT	80CRI	90CRI
2700K	N/A	0.792
3000K	0.943	0.815
3500K	1.000	0.861
4000K	1.010	0.892
5000K	1.010	0.892

Lumen Maintenance

Ambient Temperature	TM-21 Lumen Maintenance (60,000 hours) ⁽¹⁾	Theoretical L70 (Hours) ⁽²⁾
25°C	>90%	>100,000

Notes: (1) Supported by IES TM-21 standards. (2) Theoretical values represent estimations commonly used; however, refer to the IES position on LED Product Lifetime Prediction, IES PS-10-18, that explains proper use of IES TM-21 and LM-80.

Color Data (3500K)

		80CRI	90CRI
TM-30-15	R _f	85.3	90.8
	R _g	97.3	99.7
CRI/CIE	R _a	85.2	94.8
	R _s	17.2	70.7

80CRI

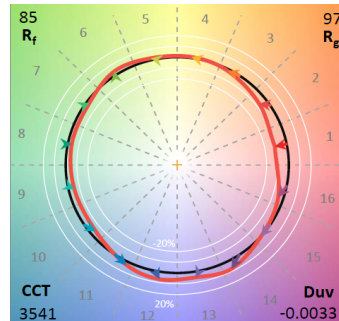

90CRI

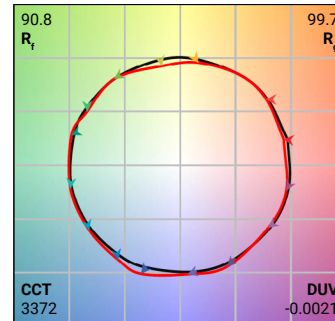

Proven Research. Industry Recognized.

BioUp Melanopic Lighting



See better



Feel better



Function better



See [BioUp brochure](#) for more details



ANSI/IES RP-46-23 / TM18 published March 2024 based on over 40 years of research.

"...circadian clock synchronization is paramount to the body's efficient and appropriate functioning." – TM18



BioUp solutions maximize WELL points for Circadian Lighting Design (L03):

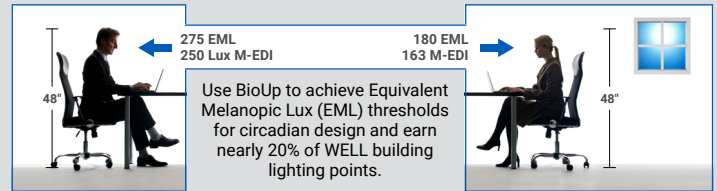

MDER, M-EDI and **EML** are key metrics used to quantify non-visual performance of indoor lighting systems.

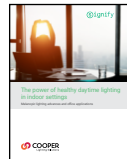

See [BioUp white paper](#) for more details

MDER - Melanopic Daylight Efficacy Ratio (MDER) measures the amount of light stimulating to the melanopsin receptors.

Standard 4000K LED
MDER = .62

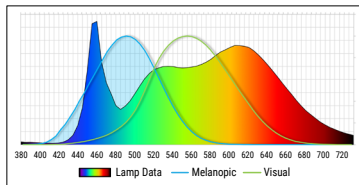

BioUp 4000K LED
MDER = .82

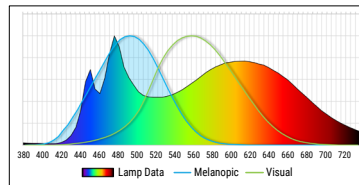

30% boost Biological impact compared to traditional LED sources

CCT	LED MDER ~83 CRI	BioUp Static		BioUp Dynamic	
		MDER	CRI	MDER	CRI
2700K	0.44	-	-	0.43	95
3000K	0.49	-	-	0.54	94
3500K	0.56	0.71	90	0.71	90
4000K	0.64	0.84	87	0.82	87
5000K	0.77	0.98	84	0.98	84

BioUp enhances the LED spectrum with cyan light at 475nm increasing the biological impact of the light to enhance our circadian rhythm which regulates our sleep/wake cycle, daytime engagement, and mood – **all without distorting visual color impression.**

Static (non-tunable)

Static BioUp is used when simple Melanopic Lighting is desired at all times.

Arrow in graph shows BioUp spectrum boost is at 475nm where non-visual biological response is enhanced.

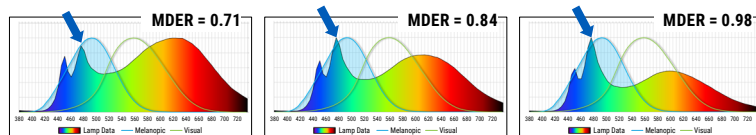

3500K or **4000K** or **5000K**

Cyan light component always present



no CCT control needed

Dynamic - (Tunable)

Dynamic BioUp is used when Melanopic Lighting is desired to adjust during the day.

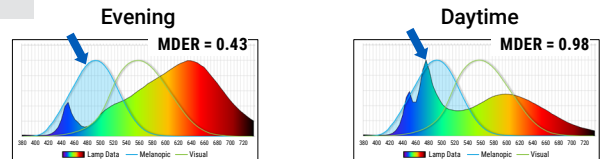

Warmer CCT Without Cyan content ← → Cooler Light With Cyan content

2700K – 5000K



Control with Wavelinx, 2ch 0-10V, or DALI

BioUp Photometry

Legend: • Available
- Unavailable

4in	DIRECT	
Nominal Output	BioUp Light Engine	B35 efficacy
lm/ft	W/ft	lm/W
350	-	-
575	6.0	95.8
795	8.6	92.4
1020	11.5	88.7
1195	-	-

0-10V						
Availability						
Lumens/ft	350	575	795	1020	1195	
Fixture Length	4	-	•	•	•	-
	5	-	•	•	-	-
	6	-	•	•	•	-
	7	-	•	•	-	-
	8	-	•	•	•	-
	9	-	•	•	-	-
	10	-	•	•	•	-
	11	-	•	•	-	-
	12	-	•	•	•	-

DALI						
Availability						
Lumens/ft	350	575	795	1020	1195	
Fixture Length	4	-	•	•	•	-
	5	-	•	•	-	-
	6	-	•	•	•	-
	7	-	•	•	-	-
	8	-	•	•	•	-
	9	-	•	•	-	-
	10	-	•	•	•	-
	11	-	•	•	-	-
	12	-	•	•	•	-

VividTune™

color tuning solutions

Define with VividTune Tunable White

VividTune tunable white luminaires deliver high-quality light in a broad range of continuously variable color temperatures and intensities. Create a dynamic environment by adjusting the ambient light warmer or cooler to influence mood, support the task at hand, or create a dramatic ambience. The ability to control correlated color temperature and intensity separately using simple controls is the next evolution of LED lighting for the commercial, educational, healthcare and hospitality space. The unparalleled flexibility and number of available lighting environments enable users to find the right light with tunable white.

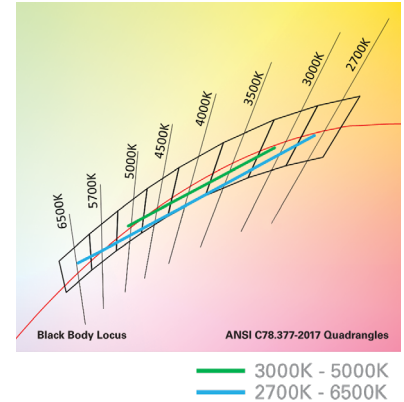

Performance Data

Tunable White - Lumen Adjustment Factors				
CCT	3000K-5000K		2700K-6500K	
	80 CRI	90 CRI	80 CRI	90 CRI
2700K	-	-	0.868	0.741
3000K	0.894	0.736	0.893	0.771
3500K	0.946	0.804	0.924	0.809
4000K	0.993	0.868	0.944	0.835
4500K	1.002	0.883	0.961	0.857
5000K	1.002	0.883	0.974	0.874
6500K	-	-	0.988	0.897

Controlling VividTune Tunable White

VividTune luminaires make tunable white more accessible by using simple and familiar controls. From wall dimmers to wireless controls, VividTune tunable white luminaires are compatible with industry standard 0-10V dimming controls. A single 0-10V dimming input is used to control intensity (brightness) while a second 0-10V dimming input is used to adjust CCT. For suggested control configurations, go to www.cooperlightingsolutions.com for tunable white application guides.

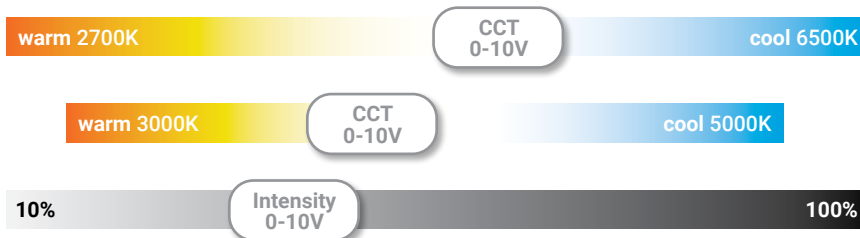

Control Solutions

- WaveLinx LITE wireless
- WaveLinx PRO wireless
- WaveLinx CAT wired
- WaveLinx Wired



Define with WaveLinx offers no-hassle lighting control with multiple luminaire level control solutions.



WaveLinx PRO is a wireless lighting control solution, for connected spaces, that significantly reduces a building's energy consumption. From a single floor to an entire campus, WaveLinx PRO connects more than lighting assets; it shares aggregated sensor data with the WaveLinx CORE platform and other building systems, so building owners can improve operations, spaces environment, and tenants' experience. WaveLinx PRO offers a rich portfolio of wireless devices, WaveLinx PRO-enabled luminaires, and an intuitive WaveLinx mobile app for office, education, warehouse, and parking garage applications.



WaveLinx LITE is a cost effective, wireless digital lighting control solution, with out-of-the-box functionality, that saves energy and meets code. It's designed for applications that require occupancy-based, daylighting, or manual light control. Customize installations for office, education, warehouse and parking garages using the secure, simple mobile app.

Integrated Sensor Coverage Pattern

TOP VIEW:

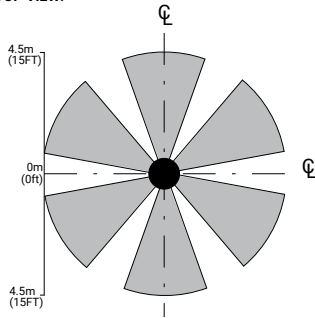

SIDE VIEW:

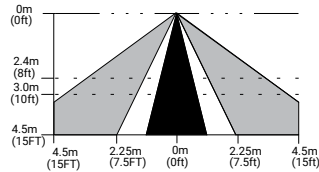

Note: Installation of integrated sensors within 3-ft (1m) of HVAC air vents is not recommended. The pattern shown is intended solely as a general guide and is not to scale.

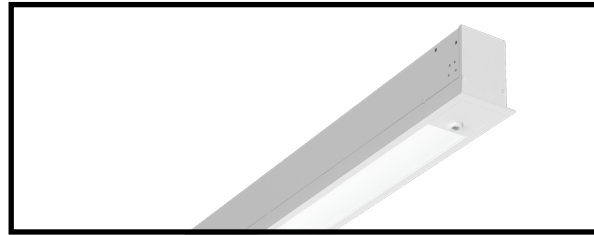

Luminaire with standalone sensor



Standalone Spaces WaveLinx LITE



Standalone Spaces WaveLinx CAT



Networked Spaces WaveLinx PRO



Enterprise WaveLinx CORE

	Luminaire with standalone sensor	Standalone Spaces WaveLinx LITE	Standalone Spaces WaveLinx CAT	Networked Spaces WaveLinx PRO	Enterprise WaveLinx CORE
Occupancy	Yes	Yes	Yes	Yes	Yes
Daylighting	Yes	Yes	Yes	Yes	Yes
Wallstations	-	Yes	Yes	Yes	Yes
Gateways	-	-	-	1 WAC	300 WACs
Devices (MAX)	-	40 per Area (1120 per space)	40 per Area	200 per WAC2	32,500 per CORE Enterprise
Software	-	WaveLinx LITE Mobile App	WaveLinx CAT Mobile App	WaveLinx Mobile App	CORE
Areas	-	28 per Space	Unlimited	50 per WAC2	up to 3,000
Zones	-	16 per Area	16 per Area	16 per Area	up to 9,000
Scheduling	-	-	-	Local	Global
VividTune™	-	-	-	Yes	Yes
Plug-Load Control	-	Yes	Yes	Yes	Yes
Low-Voltage Power	-	-	Yes	Yes	Yes
Integration	-	-	-	-	BACnet, API
Dashboards	-	-	-	-	Energy, Occupancy
Configuration	-	Installer	Installer	Technician	Technician / IT

SCALABILITY



WaveLinx expands from a single standalone device up to Enterprise with 32,500 devices

**Note: WaveLinx LITE devices can be upgraded to WaveLinx PRO via an OTA firmware update. The OTA and system configuration can only be performed by Cooper Lighting Solutions specialists. WaveLinx Area Controller(s) would also need to be added to complete the solution.*

Integrated Sensors

Refer to default sensor details below for integrated sensor locations of individual and straight runs. Please include preferred integrated sensor locations when providing sketch/drawing for a custom pattern.

- Standard Sensor with Luminaire Control
- Auxiliary Sensor used for Sensor Coverage

Individual Luminaire Default Sensor Placement

≤8ft Individual

>8ft Individual

Straight Run Default Sensor Placement

Beginning of Run (BOR)

Intermediate Section (INT)

End of Run (EOR) > 4ft

End of Run (EOR) ≤ 4ft

Battery Location Details

Battery Location

	< 4ft	≥ 4ft
Define 2	External (B1 or B2)	External (B1 or B2) or Internal (B3) IC Rated < 865Lm/ft
Define 3	External (B1 or B2)	Internal (B1, B2, B3) IC Rated < 1000Lm/ft
Define 4	External (B1 or B2)	Internal (B1, B2, B3) IC Rated < 1020Lm/ft
Define 5	External (B1 or B2)	Internal (B1, B2, B3) IC Rated < 1090Lm/ft

Chicago Plenum Battery Location

	< 4ft	≥ 4ft
Define 2	Consult Factory	Internal (B3) IC Rated < 865Lm/ft
Define 3	Consult Factory	Internal (B1, B2, B3) IC Rated < 1000Lm/ft
Define 4	Consult Factory	Internal (B1, B2, B3) IC Rated < 1020Lm/ft
Define 5	Consult Factory	Internal (B1, B2, B3) IC Rated < 1090Lm/ft

Luminaire Weight (lbs/ft)

2.65