

MARKETPRO™

Stock Lighting Solutions



STOCK PRODUCT GUIDE

Lighting & Controls

HALO

Metalux

LUMARK

SURE-LITES

Greengate

WaveLinX
Digital Lighting
Control Solutions

VOL. 2 | 2026



 **COOPER**
Lighting Solutions
a  Ignify business

RESIDENTIAL | COMMERCIAL | INDUSTRIAL

At Cooper Lighting Solutions, we deliver industry-leading indoor and outdoor lighting products, lighting controls, smart lighting systems, programs and services.



VISIT OUR
MARKETPRO™
WEBSITE

Your one-stop shop for tools and resources designed to help grow your business

- ✓ Product Guide
- ✓ E-Commerce Tools
- ✓ Find Utility Rebates
- ✓ Sample Before You Buy
- ✓ Marketing & Training

READILY-AVAILABLE SOLUTIONS FROM OUR TRUSTED BRANDS

The MarketPro program provides our customers with top selling lighting and controls products from industry-preferred brands for their trusted performance, reliability and quality. These products are in-stock and ready to ship to meet your project needs.

Risk-Free distributor advantages with nothing to lose and a whole lot to gain!*



FREE Freight

Free delivery to keep products flowing on and off your shelf



Guaranteed Returns

One year from purchase



Top Brands

Trusted products from HALO, Metalux, Greengate, Sure-Lites and Lumark



Proven Best Sellers

Contractor preferred top selling lighting and controls products



Utility Incentives

Products qualify for ENERGY STAR® and DLC®, saving money and adding value



Quick Solutions

Easily access our most popular, readily available products through our Quick Spec program



Sample Before You Buy

Try new products risk free



Training & Education

Online and instructor-led classes to expand your lighting and controls knowledge

* [CLICK HERE](#) to See MarketPro Terms and Conditions



Visit the MarketPro website to download the product guide

COOPERLIGHTING.COM/MARKETPRO

At Cooper Lighting Solutions, we deliver industry-leading indoor and outdoor lighting products, lighting controls, smart lighting systems, programs and services.

RESIDENTIAL

Residential lighting fixtures for single and multi-family new construction and remodel projects.



COMMERCIAL

Lighting and control solutions for healthcare, education, hospitality, retail and office.



INDUSTRIAL

Lighting and control solutions for warehouses, distribution centers and logistic facilities.



OUTDOOR

Lighting that provides easy installation, area safety, and energy savings in commercial and industrial spaces.



Explore our products!

Recessed Downlights

HALO 8

Ambient Commercial & Industrial

Metalux 32

Connected Lighting & Controls

WaveLinx 43
Digital Lighting Control Solutions

Greengate 48

Exit & Emergency

SURE-LITES 50

Outdoor Luminaires

LUMARK AP 59

LUMARK 63

HALO OUTDOOR 68



HALO



METALUX COMMERCIAL



METALUX INDUSTRIAL



SURE-LITES



LUMARK

MARKETPRO ESSENTIALS

Stock Lighting Solutions

Experience all the benefits of MarketPro **PLUS** exceptional value on your favorite Essential products!

Uniting Affordability & Performance

MarketPro™ Essentials - our go-to products for exceptional value, contractor-preferred options, and trusted performance! We are bridging the gap between cost and quality, as we deliver value with reliable effectiveness.

Explore MarketPro Essentials with Ease!



Easily spot the Essential products identified in the yellow highlighted tables and the **ES** icon.

Explore all Essentials products on our website



At Cooper Lighting Solutions, we create innovative lighting that improves safety while making buildings, homes, and cities smarter and more sustainable. Explore our latest solutions and new MarketPro products.



HALO HLC Tapered
SURFACE MOUNT

The HLC Tapered Disk Lights offer a low-profile finish and fast, tool-free installation with a 5-position CCT switch and bulk options for contractors.

PAGE 19



HALO FMNL Flush Mount with Night Light
FLUSH MOUNT

The FMNL flush mount toggles between downlight and night-light modes, featuring universal installation and interchangeable black or white trims.

PAGE 20



Metalux ProWrap Series
WRAP

The ProWrap is a low-profile LED wrap with selectable color and brightness, featuring a 2" shallow design and microprism diffuser for uniform coverage.

PAGE 37

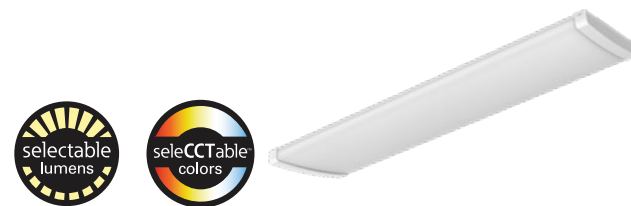

LUMARK AP XAS All Selectable
AREA/SITE

XAS All-Selectable Area Site light features 4 wattages, 3 CCTs, and 3 distributions, plus a twist-lock photocell and slipfitter or pole mounting options.

PAGE 62



HALO

**BUILT TO PERFORM.
MADE TO LAST.**



LIGHTING HOMES. POWERING PROS.

Today, HALO continues to evolve with the way people live—from the recessed fixtures that built our reputation to today's connected, energy-efficient designs. And now, we're celebrating 70 years with innovations built for pros.

TRUSTED BY PROFESSIONALS FOR SEVEN DECADES.



SELECTABILITY



FIRE SAFETY



CONNECTED BY WIZ



FLIP-N-KLIP

Explore the HALO product family at halolighting.com





Canless Downlighting



Surface Mount Downlighting



Recessed LED and Traditional Trims



Under Cabinets



Recessed Housings



Smart Wi-Fi® Lighting

GO CANLESS! Installs Virtually Anywhere!

- Field-Selectable color temperatures
- Mounts to drywall or suspended ceilings (no housing required)
- Remote driver/junction box included
- Rated for insulation contact (IC) & non-IC ceilings

Quick and Easy Installation

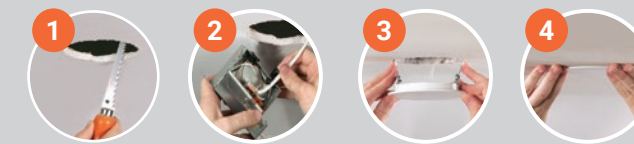

MORE FLEXIBILITY!
SAVE TIME AND MONEY!
NO HOUSING NEEDED!

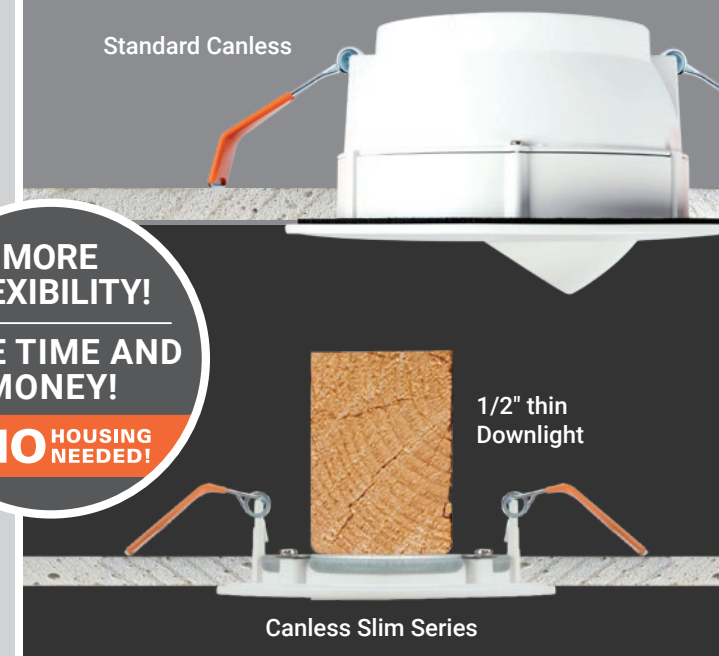

New Construction Mounting Frames and Smash Plate For Installing Canless Downlights in New Construction

- Use HALO Mounting Frames/Smash Plates on your next new construction project
- Toolless thumbscrews hold remote driver/jbox to the frame during rough in
- **MF Series** - 4" & 6" rounds with 1/2" drywall collar
- **HL Series** - 3", 4", 6", & 8" rounds that convert to squares with corner knockouts
- **Smash Plate** - Our most cost-effective single frame solution that can fit 3", 4", or 6" HALO Canless Fixtures (convert 4" or 6" openings to squares with corner knockouts)

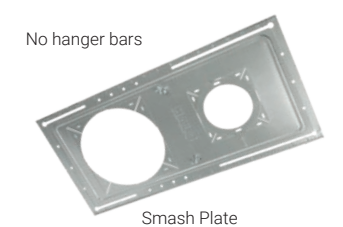
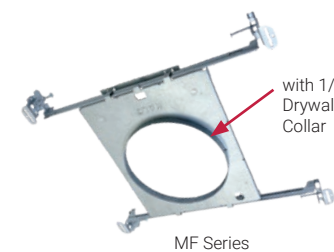
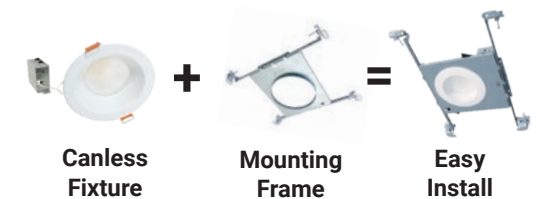

Catalog Number	Description	UPC
MF4RC	4" Round Mounting Frame with 1/2" Drywall Collar	080083268009
MF6RC	6" Round Mounting Frame with 1/2" Drywall Collar	080083268023
HL3RSMF	3" Round/Square Mounting Frame	080083876143
HL4RSMF	4" Round/Square Mounting Frame	080083876167
HL6RSMF	6" Round/Square Canless Mounting Frame	080083876181
HL8RSMF	8" Round/Square Canless Mounting Frame	080083890460
SP346RS	3"/4"/6" Round/Square Smash Plate	080083288236

HALO

RECESSED LED DOWNLIGHTS

HALO is the industry leader in high-quality recessed downlighting, offering the widest selection of innovative and flexible solutions for your application needs.

HALO CANLESS DOWNLIGHTING

SLIM CANLESS DOWNLIGHT Product Selection Guide

Good Better Best

		MarketPro Essentials			
		HLBE & HLBSL	HLBPH	HLB/HLBFR	HLBC/HLBC+
FEATURES/PERFORMANCE	Slim 1/2" Thin	✓	✓	✓	✓ with regressed lens + 2-in-1 (Canless-to-Can) Install Option
	Size / Shape	4", 6" Round	4", 6" Round	3", 4", 6", 8", 12" Round, Square	4", 6" Round, Square ¹
	Lens	Smooth	Smooth	Low-glare Prismatic	Regressed, Low-glare Prismatic
	Max Lumens (By size @ 3000K)	745, 1,025	805, 1,015	595, 790, 1,020, 2,350, 2,300 (Lumen Select, Dedicated)	975, 1,270 (Lumen Select, Dedicated)
	Color Temperatures (CCT)	5 CCT 27/30/35/40/5000K Dedicated: 3000K	6 CCT 27/30/35/40/50/6500K	5 CCT 27/30/35/40/5000K	5 CCT w/ D2W D2W/27/30/35/40/5000K
CONTROL	Dimming	10% Phase Cut	5% Phase Cut	5% Phase Cut, 0-10V ²	5% Phase Cut, 0-10V
	Estimated Life Hours	35,000	50,000	50,000	50,000
	Input Voltage	120V	120V	120V, 120-277V	120V, 120-277V
ACCESSORIES	Fits Mounting Frames	✓	✓	✓	✓
	Decorative Overlays ³	✓	✓	✓	✓ ¹
	Slide-in-Side™ Wire Traps ⁴		✓	✓	✓
	Mounting Bar	✓ ⁵	✓	✓	✓

¹ Overlay Trims sold separately. ² Available in QuickLink Low Voltage (Phase Cut or 0-10V) or Smart Wi-Fi® Connected by WiZ Pro versions. ³ Matte Black, Tuscan Bronze, Satin Nickel, and Paintable Matte White. ⁴ Slide-N-Side wire traps eliminate the need to use knockouts in most instances. Pre-wire outside of the jbox, fold down the tab(s), and insert non-metallic sheathed cable into the Slide-N-Side strain relief. ⁵ Mounting Bars are included with HLBSL but are sold separately for the HLBE Bulk Packs (HLBEMOUNT-12PK).

HLBSL & HLBE Slim Lite CANLESS DOWNLIGHTS - 4" & 6"

- Matches the HLBPH with simplified features for budget-conscious installers
- HLBSL:** 5 Color Field-Selectable in 27/30/35/40/5000K; **HLBE:** dedicated in 3000K
- Only available in dead-front plastic frame and smooth lens
- Includes LED downlight and remote driver/junction box with mounting bar*
- 10% Phase Cut (LE/TE) Dimming, 35,000 hrs, 90+ CRI



MarketPro Essentials Selectable CCT

Catalog Number	Description	Replaces	CCT	Voltage	Lumens	Watts	UPC	Energy Star ID
ES HLBSL406FS5	4" Downlight	60-90W	2700K-5000K	120V	725	8	080083297221	3706754
ES HLBSL609FS5	6" Downlight	70-90W	2700K-5000K	120V	915	10	080083297245	3706756

MarketPro Essentials Dedicated CCT & Lumens

Catalog Number	Description	Replaces	CCT	Voltage	Lumens	Watts	UPC	Energy Star ID
ES HLBE4069301EMWR-12PK*	4" Downlight (12-Pack)	65W	3000K	120V	740	10	080083265503	2405484
ES HLBE4069301EMWR-24PK*	4" Downlight (24-Pack)	65W	3000K	120V	740	10	080083265527	2405484
ES HLBE6099301EMWR-12PK*	6" Downlight (12-Pack)	70W	3000K	120V	1,025	13	080083265541	2405486
ES HLBE6099301EMWR-24PK*	6" Downlight (24-Pack)	70W	3000K	120V	1,025	13	080083265565	2405486

HALO CANLESS DOWNLIGHTING

HLB & HLBPH Slim CANLESS DOWNLIGHTS - 3", 4", 6", 8" & 12"

- An ultra-thin flange and sleek 1/2"-thin downlight design that fits under any obstruction
- HLB:** Die-cast trim & low-glare prismatic lens; **HLBPH:** Dead-front trim & smooth lens
- 5 Color Field-Selectable in 27/30/35/40/5000K
- Includes LED downlight and remote driver/junction box with mounting bar
- 5% Dimming (Phase Cut or 0-10V), 50,000 hrs, 90+ CRI

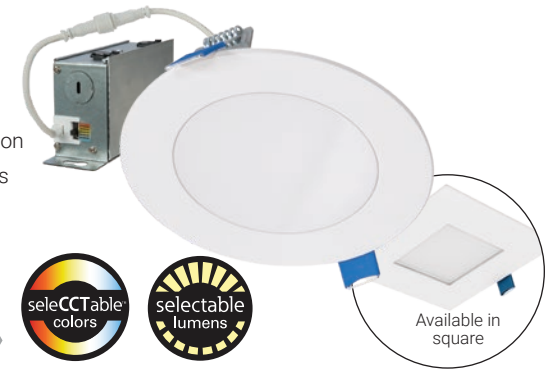

Catalog Number	Description	Replaces	Selectable CCT	Voltage	Lumens	Watts	UPC	Energy Star ID
HLB3059FS1EMWR	3" Downlight, Round	40W	2700K-5000K	120V	575	9	080083151301	2370657
HLB3S059FS1EMWR	3" Downlight, Square	40W	2700K-5000K	120V	595	9	080083151325	N/A
HLB4LSFS5	4" Downlight, Round	60-90W	2700K-5000K	120V	700/850/1000 (Lumen Select)	10	080083297306	3706760
HLB4SP069FS1EMWR	4" Downlight, Square (Round Hole)	65W	2700K-5000K	120V	650	10	080083909667	2347583
HLB6LSFS5	6" Downlight, Round	70-90W	2700K-5000K	120V	800/1000/1200 (Lumen Select)	13	080083297320	3706764
HLB6S099FS1EMWR	6" Downlight, Square	70W	2700K-5000K	120V	975	12	080083863389	2331663
HLB8169FS1EMWR	8" Downlight, Round	100W	2700K-5000K	120V	1,760	21	080083150601	2358047
HLB4069FSE010MWR	4" Downlight, Round (0-10V)	65W	2700K-5000K	120-277V	790	11	080083912261	2351376
HLB4S069FSE010MWR	4" Downlight, Square (0-10V)	65W	2700K-5000K	120-277V	725	11	080083912308	N/A
HLB6099FSE010MWR	6" Downlight, Round (0-10V)	70W	2700K-5000K	120-277V	1,060	15	080083912285	2351377
HLB6S099FSE010MWR	6" Downlight, Square (0-10V)	70W	2700K-5000K	120-277V	975	15	080083912322	N/A
HLB8LS9FSE010MWR	8" Downlight, Round (0-10V)	90-150W	2700K-5000K	120-277V	1,400/1,900/2,400 (Lumen Select)	17/25/32	080083083367	2358045
HLB12LS9FSE010MWR	12" Downlight, Round (0-10V)	90-150W	2700K-5000K	120-277V	1,300/1,900/2,300 (Lumen Select)	17/25/32	080083088782	N/A
HLBPH406FS6	4" Downlight, Round	65W	2700K-6500K	120V	790	9	080083304066	3942835
HLBPH609FS6	6" Downlight, Round	70W	2700K-6500K	120V	980	10	080083304080	3942836

HLBC/HLBC+ Slim Regressed CANLESS DOWNLIGHTS - 4" & 6"

- HLBC:** Set lumens + canless install; **HLBC+:** Lumen Select + 2-in-1 Canless-to-Can install!
- 1/2"-thin fixture with baffle die-cast trim & regressed low-glare prismatic lens
- 6-Position Switch: 5 Color Field-Selectable (27/30/35/40/5000K) + Dim-to-Warm (3000K dims to 1800K)
- Includes LED downlight and remote driver/junction box with mounting bar
- 5% Dimming (Phase Cut or 0-10V), 50,000 hrs, 90+ CRI



Catalog Number	Description	Replaces	Selectable CCT	Voltage	Selectable Lumens	Watts	UPC	Energy Star ID
HLBC4LS9FSD2W1EMWR	4" Downlight, 2-in-1 Install	60-70W	2700K-5000K+D2W	120V	600/900	9/13	080083263097	2406536
HLBC4LS9FSD2W1EMWR-CA	4" Downlight, 2-in-1 Install, CA T20	60-70W	2700K-5000K+D2W	120V	600/900	9/13	080083267927	2406535
HLBC4LS9FSD2WE010MWR	4" Downlight, 2-in-1 Install (0-10V)	60-70W	2700K-5000K+D2W	120-277V	600/900	8.5/13	080083263233	2406530
HLBC4LS9FSD2WE010MWR-CA	4" Downlight, 2-in-1 Install, CA T20, (0-10V)	60-70W	2700K-5000K+D2W	120-277V	600/900	8.5/13	080083267965	2406529
HLBC6LS9FSD2W1EMWR	6" Downlight, 2-in-1 Install	70-75W	2700K-5000K+D2W	120V	900/1,200	11/16	080083263219	2406539
HLBC6LS9FSD2W1EMWR-CA	6" Downlight, 2-in-1 Install, CA T20	70-75W	2700K-5000K+D2W	120V	900/1,200	11/16	080083267941	2406538
HLBC6LS9FSD2WE010MWR	6" Downlight, 2-in-1 Install (0-10V)	70-75W	2700K-5000K+D2W	120-277V	900/1,200	11.5/16.5	080083263257	2406534
HLBC6LS9FSD2WE010MWR-CA	6" Downlight, 2-in-1 Install, CA T20 (0-10V)	70-75W	2700K-5000K+D2W	120-277V	900/1,200	11.5/16.5	080083267989	2406532
HLBC4069FSD2W1EMW	4" Downlight, Canless Only	60W	2700K-5000K+D2W	120V	675 (Dedicated)	8	080083263059	2406524
HLBC6099FSD2W1EMW	6" Downlight, Canless Only	70W	2700K-5000K+D2W	120V	1,010 (Dedicated)	12	080083263073	2406527

CANLESS DOWNLIGHT Product Selection Guide



	MarketPro Essentials			MarketPro Essentials			
	DOWNLIGHTS			ADJUSTABLES			
	LT Canless	CJB/CJB+ Canless/2-in-1	RL, RLF, RL Night Light Canless	HLA Canless	RA Canless	RLS Slope Canless	
FEATURES / PERFORMANCE	Fixture Types	Recessed Downlights	Slim Downlight with Attached Jbox + 2-in-1 Canless-to-Can Versions Available	Recessed Downlights, Fire Rated Downlight, & Downlight + Night Light	Super Adjustable Gimbals (90° Tilt/360° Rotation)	Gimbal Adjustables (35° Tilt/360° Rotation)	Regressed Slope Adjustable (9-45° Tilt)
	Sizes (Round)	3", 4", 6"	4", 6"	4", 6"	3", 4", 6"	4", 6"	4", 6"
	Trim & Lens	Baffle or Smooth Trim w/ Flat Lens	Slim Trim w/ Flat Smooth Lens	Baffle Trim w/ Curved Lens (NL has Transparent Trim)	Slim Trim w/ Flat Smooth Lens	Baffle Trim w/ Flat Lens	Deep Baffle Trim w/ Integrated Optic
	Max Lumens (By size @ 3000K)	570, 645, 785	745, 920	955, 1,300 (Lumen Select, Dedicated) (NL: 780, 1,020)	610, 660, 990	Lumen Select 4" - 600/900 6" - 600/900	960, 1,630
	Color Temperatures (CCT)	3CCT 27/30/3500K, 30/40/5000K, Dedicated: 3000K	5 CCT 27/30/35/40/5000K	5 CCT w/ D2W D2W/27/30/35/40/5000K (NL: 2000K)	5 CCT 27/30/35/40/5000K	5 CCT w/ D2W D2W/27/30/35/40/5000K	5 CCT 27/30/35/40/5000K
CONTROL	Dimming Phase Cut (LE/TE)/0-10V	10% Phase Cut ¹	10% Phase Cut	5% Phase Cut, 0-10V ² , ³ (NL: 5% Phase Cut - Both zones)	5% Phase Cut	5% Phase Cut ³	5% Phase Cut
	Estimated Life Hours	35,000	35,000	70,000 (RLFR & RLNL: 50,000)	50,000	50,000	50,000
	Input Voltage	120V	120V	120V	120V	120V	120V
HARDWARE	Fits Mounting Frames/Smash Plate	✓	✓	✓	✓	✓	✓
	Decorative Overlays ⁴	✓		✓	✓		✓
	Slide-in-Side™ Wire Traps ⁵			✓	✓	✓	✓
	Mounting Bar	✓		✓	✓	✓	✓

¹ LTs are also available in QuickLink Low Voltage (Phase Cut) versions. ² Available in QuickLink Low Voltage (0-10V) versions. ³ Available in Smart Wi-Fi® Connected by WiZ Pro versions. ⁴ Matte Black, Tuscan Bronze, Satin Nickel, and Paintable Matte White. ⁵ Slide-N-Side wire traps eliminate the need to remove knockouts. Pre-wire outside of the j-box, fold down the tab, and insert non-metallic sheathed cable into the Slide-N-Side strain relief.

LT Recessed Trim

CANLESS DOWNLIGHTS - 3", 4", & 6"

- Closely mirrors the RL design with simplified features for maximum savings
- Dead-front plastic baffle trim and flat lens + Smooth Splay Overlays
- 5 Color Field-Selectable in 27/30/35/40/5000K
- Includes LED downlight and remote driver/junction box with mounting bar
- 10% Dimming (Phase Cut LE/TE), 35,000 hrs, 90+ CRI

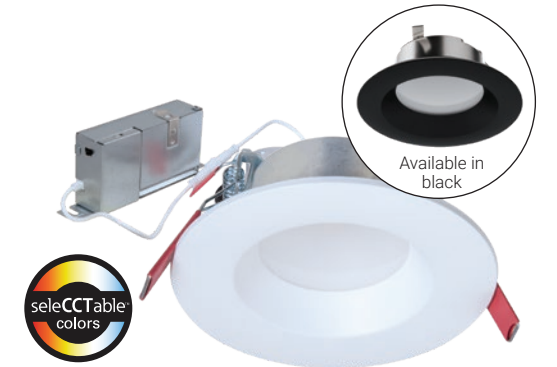

MarketPro Essentials

Catalog Number	Description	Replaces	Selectable CCT	Voltage	Lumens	Watts	UPC	Energy Star ID
ES LTC305FS5B	3" Baffle Downlight	60W	2700K-5000K	120V	550	6	080083297047	3557102
ES LTC305FS5BMB	3" Baffle Downlight, Black	60W	2700K-5000K	120V	550	6	080083309382	4437375
ES LTC406FS5B	4" Baffle Downlight	60W	2700K-5000K	120V	650	7.2	080083297061	Pending
ES LTC406FS5BMB	4" Baffle Downlight, Black	60W	2700K-5000K	120V	650	7.2	080083309405	Pending
ES LTC608FS5B	6" Baffle Downlight	60W	2700K-5000K	120V	750	8.5	080083297085	Pending
ES LTC608FS5BMB	6" Baffle Downlight, Black	60W	2700K-5000K	120V	750	8.5	080083309429	Pending
ES LTC608B-MF6RC-6PK	6" Baffle & Mounting Frames (6-Pack Kit)	60W	2700K-5000K	120V	750	8.5	080083297504	Pending

Accessories (optional)

Catalog Number	Description	Finish	UPC	Catalog Number	Description	Finish	UPC
LT30MW	3" Smooth Splay Overlay	Matte White	080083297528	LT30MB	3" Smooth Splay Overlay	Matte Black	080083297580
LT40MW	4" Smooth Splay Overlay	Matte White	080083297542	LT40MB	4" Smooth Splay Overlay	Matte Black	080083297603
LT60MW	6" Smooth Splay Overlay	Matte White	080083297566	LT60MB	6" Smooth Splay Overlay	Matte Black	080083297627

CJB/CJB+ Integrated JBox

CANLESS DOWNLIGHTS - 4" & 6"

- Standard CJB is canless while the CJB+ features 2-in-1 installation for fast Canless-to-Can conversion!
- Slim flat trim and smooth lens
- 5 Color Field-Selectable in 27/30/35/40/5000K
- 10% Dimming (Phase Cut LE/TE), 35,000 hrs, 90+ CRI



Catalog Number	Description	Replaces	Selectable CCT	Voltage	Lumens	Watts	UPC	Energy Star ID
CJB4069FS1EMWR	4" Downlight, 2-in-1 Install	60W	2700K-5000K	120V	745	8	080083266470	2508445
CJB6099FS1EMWR	6" Downlight, 2-in-1 Install	70W	2700K-5000K	120V	920	9	080083266494	2508446
CJB4069FS1EMWR-6PK	4" Downlight, 2-in-1 Install (6-Pack)	60W	2700K-5000K	120V	745	8	080083266517	2508445
CJB6099FS1EMWR-6PK	6" Downlight, 2-in-1 Install (6-Pack)	70W	2700K-5000K	120V	920	9	080083266531	2508446
CJB4069FS1EMWR-12P	4" Downlight, 2-in-1 Install (12-Pack)	60W	2700K-5000K	120V	745	8	080083266555	2508445
CJB6099FS1EMWR-12P	6" Downlight, 2-in-1 Install (12-Pack)	70W	2700K-5000K	120V	920	9	080083266579	2508446
CJB4069FS1EMW	4" Downlight, Canless Only	60W	2700K-5000K	120V	745	8	080083266234	2508445
CJB6099FS1EMW	6" Downlight, Canless Only	70W	2700K-5000K	120V	920	9	080083266258	2508446
CJB4069FS1EMW-6PK	4" Downlight, Canless Only (6-Pack)	60W	2700K-5000K	120V	745	8	080083266272	2508445
CJB6099FS1EMW-6PK	6" Downlight, Canless Only (6-Pack)	70W	2700K-5000K	120V	920	9	080083266296	2508446
CJB4069FS1EMW-12PK	4" Downlight, Canless Only (12-Pack)	60W	2700K-5000K	120V	745	8	080083266418	2508445
CJB6099FS1EMW-12PK	6" Downlight, Canless Only (12-Pack)	70W	2700K-5000K	120V	920	9	080083266432	2508446

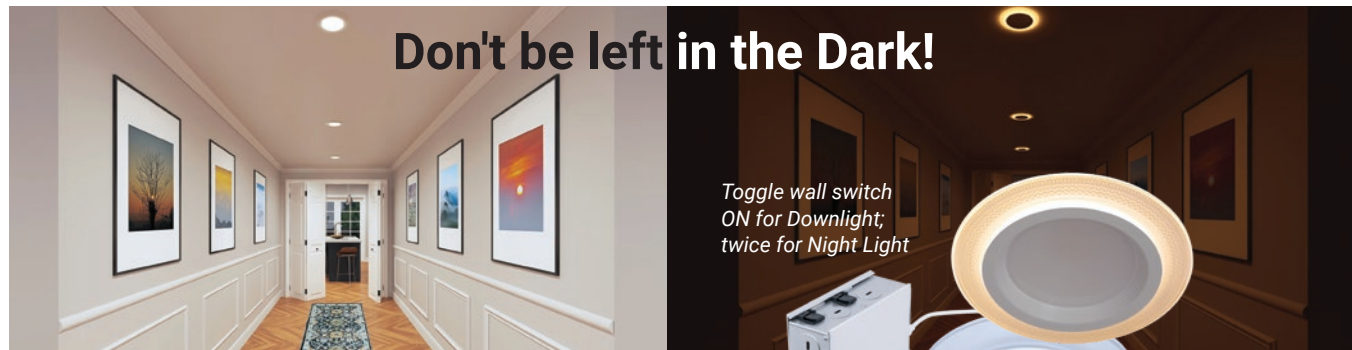

RL Night Light

CANLESS DOWNLIGHTS & RECESSED LED TRIMS - 4" & 6"

- 2 Modes: Downlight for general illumination and Night Light with gentle glow (2000K)
- Dead-front plastic trim with smooth splay and curved lens
- 6-Position Switch: 5 Color Field-Selectable (27/30/35/40/5000K) + Dim-to-Warm (3000K dims to 1800K); Night Light CCT: Warm glow 2000K
- 5% Dimming (Phase Cut LE/TE), 70,000 hrs, 90+ CRI



Canless LED Downlights with remote/driver/junction box

Catalog Number	Description	Replaces	Selectable CCT	Voltage	Lumens	Watts	UPC	Energy Star ID
RLNL4079FSD2W1EWHDM	4" Night Light + Downlight	65W	2700K-5000K + D2W + Night Light (2000K)	120V	780	9	080083265039	2403400
RLNL6109FSD2W1EWHDM	6" Night Light + Downlight	70W	2700K-5000K + D2W + Night Light (2000K)	120V	1,020	12	080083265053	2403403

Recessed LED Trims with E26 medium socket adapter, and mounting hardware (4"-friction blades and 5"/6"-torsion springs & friction blades)

Catalog Number	Description	Replaces	Selectable CCT	Voltage	Lumens	Watts	UPC	Energy Star ID
RLNL4079FSD2W1EWH	4" Night Light + Downlight Trim	65W	2700K-5000K + D2W + Night Light (2000K)	120V	775	8	080083268047	2409525
RLNL6109FSD2W1EWH	5"/6" Night Light + Downlight Trim	75W	2700K-5000K + D2W + Night Light (2000K)	120V	1,065	11	080083268061	2409524

RL Recessed Baffle Trim

CANLESS DOWNLIGHTS - 4" & 6"

- The perfect balance of value and visual comfort, available as a canless direct mount
- NEW! Flip-N-Klip Canless Locking Springs - No more pinched fingers!
- Die-cast aluminum baffle trim with curved lens and selectable lumen options
- 6-Position Switch: 5 Color Field-Selectable (27/30/35/40/5000K) + Dim-to-Warm (3000K dims to 1800K)
- LED downlight with remote driver/junction box
- 5% Phase Cut (LE/TE) Dimming, 70,000 hrs, 90+ CRI



Catalog Number	Description	Replaces	Selectable CCT	Voltage	Lumens	Watts	UPC	Energy Star ID
RL4LS9FSD2W1EWHDM	4" Baffle Downlight	60-70W	2700K-5000K+D2W	120V	600/900	7.5/11.5	080083258901	2403141
RL6069FSD2W1EWHDM	6" Baffle Downlight	60W	2700K-5000K+D2W	120V	750 (Dedicated)	7	080083258963	2402947
RL6LS9FSD2W1EWHDM	6" Baffle Downlight	70-75W	2700K-5000K+D2W	120V	900/1,200	10/14	080083258987	2403144



HLA Super Adjustable Gimbal

CANLESS DOWNLIGHTS - 3", 4" & 6"

- Aim lighting where you want it with 360° of rotation and 90° of tilt!
- NEW! Flip-N-Klip Canless Locking Springs - No more pinched fingers!
- Ideal for shallow plenum spaces - requires only 1-1/2" above the ceiling
- 5 Color Field-Selectable in 27/30/35/40/5000K
- Includes LED downlight and remote driver/junction box with mounting bar
- 5% Dimming (Phase Cut LE/TE), 50,000 hrs, 90+ CRI



MarketPro Essentials

Catalog Number	Description	Replaces Up To	Selectable CCT	Voltage	Lumens	Watts	UPC	Energy Star ID
ES HLA305FS5	3" Super Adjustable	60W	2700K-5000K	120V	610	10	080083301201	4020741
ES HLA406FS5	4" Super Adjustable	60W	2700K-5000K	120V	660	12	080083301225	4020742
ES HLA609FS5	6" Super Adjustable	70W	2700K-5000K	120V	990	14	080083301249	4020743



RA Baffle Trim Adjustable Gimbal

CANLESS DOWNLIGHTS - 4" & 6"

- Aim lighting where you want it with 360° of rotation and 35° of tilt
- Regressed baffle for increased cutoff
- 6-Position Switch: 5-Color Field-Selectable (27/30/35/40/5000K) + Dim-to-Warm (3000K dims to 1800K)
- Includes LED downlight and remote driver/junction box with mounting bar
- 5% Dimming (Phase Cut LE/TE), 50,000 hrs, 90+ CRI



Catalog Number	Description	Replaces	Selectable CCT	Voltage	Selectable Lumens	Watts	UPC	Energy Star ID
RA4LS9FSD2W1EWHDM	4" Adjustable Baffle Downlight	65W	2700K-5000K + D2W	120V	600/900	9	080083283019	2351865
RA6LS9FSD2W1EWHDM	6" Adjustable Baffle Downlight	65W	2700K-5000K + D2W	120V	600/900	9	080083283033	2351876



RLS Slope Recessed Baffle Trim Adjustable

CANLESS DOWNLIGHTS - 4" & 6"

- Tilt the adjustment mechanism from 9° to 45° to match ceiling pitches from 2/12 to 12/12
- Better lighting and improved visual comfort with its integrated optic and regressed light engine
- 5 Color Field-Selectable in 27/30/35/40/5000K
- Includes LED downlight and remote driver/junction box with mounting bar
- 5% Dimming (Phase Cut LE/TE), 50,000 hrs, 90+ CRI



Catalog Number	Description	Replaces	Selectable CCT	Voltage	Lumens	Watts	UPC	Energy Star ID
RLS4099FS1EWHDMR	4" Slope Ceiling Recessed Downlight, White	70W	2700K-5000K	120V	960	11	080083190300	2382794
RLS6159FS1EWHDMR	6" Slope Ceiling Recessed Downlight, White	150W	2700K-5000K	120V	1,630	19	080083190324	2382795
RLS4099FS1EMBDMMR	4" Slope Ceiling Recessed Downlight, Black	70W	2700K-5000K	120V	960	11	080083293452	2382794
RLS6159FS1EMBDMMR	6" Slope Ceiling Recessed Downlight, Black	150W	2700K-5000K	120V	1,630	19	080083293476	2382795



HALO CANLESS DOWNLIGHTING

ML Flex

CANLESS DOWNLIGHTS - 1", 2", 3" & 4"

- Available in Downlight, Wallwash and Adjustable configurations in sizes 1"-4"
- Round trims with deep regression for better glare control
- 5 Color Field Selectable, or Field Selectable Dim-to-Warm, plus 3 levels of lumen selection
- <5% dimming in either Phase Cut (LE/TE) dimming or 0-10V (UNV 120-277V) dimming
- Mounting frames with collar and Mud-in Flushmount rings available in round



Catalog Number	Description	Replaces	Selectable CCT	Voltage	Selectable Lumens	Watts	UPC
ML1LSFS1ERMW	1" Round Downlight, Matte White	40-60W	2700K-5000K	120	100/200/400	2/3/6	080083308941
ML2LSFS1ERMW	2" Round Downlight, Matte White	40-60W	2700K-5000K	120	200/400/550	4/6/8	080083308934
ML3LSFS1ERMW	3" Round Downlight, Matte White	60-70W	2700K-5000K	120	600/800/1000	8/11/14	080083310470
ML4LSFS1ERMB	4" Round Downlight, Matte White	60-75W	2700K-5000K	120	600/900/1200	10/14/17	080083308743
ML4LSFS1ERMW	4" Round Downlight, Matte Black	60-75W	2700K-5000K	120	600/900/1200	10/14/17	080083308910
ML2ALSFS1ERMW	2" Round Adjustable, Matte White	40-60W	2700K-5000K	120	200/400/550	4/6/8	080083443871
ML2ALSFS1ERMB	2" Round Adjustable, Matte Black	40-60W	2700K-5000K	120	200/400/550	4/6/8	080083443918
ML3ALSFS1ERMW	3" Round Adjustable, Matte White	40-60W	2700K-5000K	120	300/500/750	4/7/10	080083444236
ML3ALSFS1ERMB	3" Round Adjustable, Matte Black	40-60W	2700K-5000K	120	300/500/750	4/7/10	080083444274
ML4ALSFS1ERMW	4" Round Adjustable, Matte White	60-70W	2700K-5000K	120	600/800/1000	8/11/13	080083396856
ML4ALSFS1ERMB	4" Round Adjustable, Matte Black	60-70W	2700K-5000K	120	600/800/1000	8/11/13	080083396894

Accessories (optional)

Catalog Number	Description	UPC
MFML1R	1" Round ML Flex New Construction Mounting Frame with collar	080083308217
MFML2R	2" Round ML Flex New Construction Mounting Frame with collar	080083308255
MFML3R	3" Round ML Flex New Construction Mounting Frame with collar	080083308293
MFML4R	4" Round ML Flex New Construction Mounting Frame with collar	080083308538
MFMLA2R	2" Adjustable Round ML Flex New Construction Mounting Frame with collar	080083308576
1MFMR	1" Mud Ring Flushmount Round	080083445837
2MFMR	2" Mud Ring Flushmount Round	080083445875
3MFMR	3" Mud Ring Flushmount Round	080083446117
4MFMR	4" Mud Ring Flushmount Round	080083446155

HALO FIRE SAFE SOLUTIONS

RLFR Fire Rated Recessed Baffle Trim

CANLESS DOWNLIGHTS - 4" & 6"

- Prevent the passage of flames & toxic gases for up to 2 hours
- Die-cast aluminum baffle trim and curved lens
- 5 Color Field-Selectable in 27/30/35/40/5000K
- Includes LED downlight and remote driver/junction box with mounting bar
- 5% Dimming (Phase Cut LE/TE), 50,000 hrs, 90+ CRI



Catalog Number	Description	Finish	Replaces	Selectable CCT	Voltage	Lumens	Watts	UPC	Energy Star ID
RLFRC4FS	4" Fire Rated Baffle Downlight	White	70W	2700K-5000K	120V	1,000	11	080083295838	3549872
RLFRC4FSMBB	4" Fire Rated Baffle Downlight	Black	70W	2700K-5000K	120V	900	11	080083295876	3549872
RLFRC6FS	6" Fire Rated Baffle Downlight	White	75W	2700K-5000K	120V	1,400	13	080083295852	3549873
RLFRC6FSMBB	6" Fire Rated Baffle Downlight	Black	75W	2700K-5000K	120V	1,200	13	080083295890	3549873

HLBFR Fire Rated Slim

CANLESS DOWNLIGHTS - 4" & 6"

- Prevent the passage of flames & toxic gases for up to 2 hours
- Sleek 5/8"-thin downlight design fits under any obstruction in fire rated ceilings
- Die-cast trim & low-glare prismatic lens
- 5 Color Field-Selectable in 27/30/35/40/5000K
- Includes LED downlight and remote driver/junction box with mounting bar
- 5% Dimming (Phase Cut LE/TE), 50,000 hrs, 90+ CRI

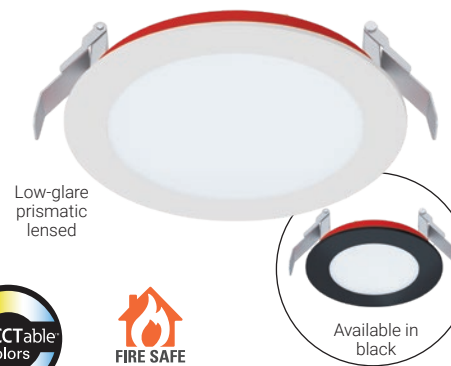

Catalog Number	Description	Finish	Replaces	Selectable CCT	Voltage	Lumens	Watts	UPC	Energy Star ID
HLBFR407FS5	4" Fire Rated Downlight, Round	White	65W	2700K-5000K	120V	690	10	080083304950	4005521
HLBFR407FS5MB	4" Fire Rated Downlight, Round	Black	65W	2700K-5000K	120V	690	10	080083304974	4005518
HLBFR609FS5	6" Fire Rated Downlight, Round	White	70W	2700K-5000K	120V	1035	14	080083304998	4005519
HLBFR609FS5MB	6" Fire Rated Downlight, Round	Black	70W	2700K-5000K	120V	995	14	080083305117	4005520

JBox Housing - 4"

- For use with all 4" HALO Recessed LED Trims and any HALO Surface Mount Fixture
- Meets UL514A Metallic Outlet Box
- Pass-N-Thru™ hangar bars allow for toolless shortening in tight spaces (7" to 24")
- For installation in insulated contact (IC) and non-IC ceilings
- All-Nail!™ preinstalled nail and integral T-grid clips allow for easy single-person installation



Catalog Number	Description	Voltage	UPC
JB4FR2	4" Junction Box Housing for use in standard or fire-rated ceilings	120-277V	080083290307

1. Use with T24-listed LED trims or surface mount fixtures.
2. Can be used to meet requirement when used with AIR-TITE or wet location-listed LED trim or surface mount fixture.

HALO SURFACE MOUNT DOWNLIGHTING

Suitable for a variety of applications!

- Below the ceiling installation with no plates or clips required
- Designed for square, octagon, pancake or round junction boxes
- Ideal for closets, storage areas, attics and basements

Quick and Easy Installation



HALO SURFACE MOUNT DOWNLIGHT Product Selection Guide

		Good		Better		Best
		MarketPro Essentials	MarketPro Essentials	FMNL	SMD	SMX
		HLCE MS	HLC			
FEATURES/PERFORMANCE	Size / Shape	4", 6" Round	4", 6" Round	8", 11", 15" Round	4", 6" Round, Square	4", 6", 8", 14", 18" Round, Square
	Trim & Lens	Curved Trim & Lens		Full-lensed Flushmount with Night Light	Square-Edge Trim, Flange, & Flat Lens	Thin Frame and Edgeless Luminous Lens
	Max Lumens (By size @ 3000K)	1035 or 1260	670, 970	980, 1185, 1540	740, 790	Lumen Select 4" - 650/800/1,000 6" - 750/900/1,200 8" - 900/1,200/1,500 14" - 1,200/1,600/2,000 18" - 1,500/2,000/2,500
	Color Temperatures (CCT)	5 CCT 27/30/35/40/ 5000K	5 CCT 27/30/35/ 40/5000K	5 CCT 27/30/35/40/ 5000K	5 CCT 27/30/35/ 40/5000K	5 CCT w/ D2W D2W/27/30/35/ 40/5000K
CONTROL	Dimming Phase Cut (LE/TE) / 0-10V	5% Phase Cut	10% Phase Cut	10% Phase Cut	5% Phase Cut, 0-10V	5% Phase Cut, 0-10V
	Estimated Life Hours	50,000	50,000	50,000	50,000	50,000
	Input Voltage	120V	120V	120V	120V	120V, 120-277V
HARDWARE	Decorative Overlays ²	✓		✓	✓	✓

¹ Motion sensing downlights are not dimmable. ² Matte Black, Tuscan Bronze, Satin Nickel, and Paintable Matte White.

HALO SURFACE MOUNT DOWNLIGHTING

HLCE MS Motion Activated Disk Light SURFACE MOUNT DOWNLIGHTS - 4" & 6"

- 10 feet of motion sensing coverage automatically turns OFF after 40 seconds of no motion
- Installs in most 3-1/2" or 4" ceiling junction and pancake boxes (or retrofits into housings)
- 5 Color Field-Selectable in 27/30/35/40/5000K
- Includes LED Downlight, jbox mounting and wiring hardware, and housing retrofit kit in non-California versions
- 10% Dimming (Phase Cut LE/TE), 35,000 hrs, 90+ CRI
- NEW! Decorative overlays are available through MarketPro online



MarketPro Essentials

Catalog Number	Description	Replaces	Selectable CCT	Voltage	Lumens	Watts	UPC	Energy Star ID
ES HLCEMS410FS1E	4" Disk Light w/ Motion Sensor (Wet-listed)	70W	2700K-5000K	120V	1035	12.2	080083303069	3994257
ES HLCEMS410FS1E-6BP	4" Disk Light w/ Motion Sensor (Wet-listed) (6-Pack)	70W	2700K-5000K	120V	1035	12.2	080083303243	3994256
ES HLCEMS410FS1E-CA	4" Disk Light w/ Motion Sensor (Wet-listed), CA T20	70W	2700K-5000K	120V	1035	12.2	080083303205	3994258
ES HLCEMS612FS1E	6" Disk Light w/ Motion Sensor (Wet-listed)	70W	2700K-5000K	120V	1260	14.8	080083303083	Pending
ES HLCEMS612FS1E-6BP	6" Disk Light w/ Motion Sensor (Wet-listed) (6-Pack)	70W	2700K-5000K	120V	1260	14.8	080083303267	Pending
ES HLCEMS612FS1E-CA	6" Disk Light w/ Motion Sensor (Wet-listed), CA T20	70W	2700K-5000K	120V	1260	14.8	080083303229	Pending

HLC Tapered Disk Light SURFACE MOUNT DOWNLIGHTS - 4" & 6"

- Ultra-fast below-the-ceiling installation; no clips or plates needed
- Installs in most 3-1/2" or 4" ceiling junction and pancake boxes (or retrofits into housings)
- 5 Color Field-Selectable in 27/30/35/40/5000K
- Twist-release lens with keyhole slots for quick install and easy CCT selection
- Available in economical 24-packs
- 10% Dimming (Phase Cut LE/TE), 50,000 hrs, 90+ CRI



MarketPro Essentials

Catalog Number	Description	Replaces	Selectable CCT	Voltage	Lumens	Watts	UPC	Energy Star ID
ES HLC4FS1E-24P	4" Disk Light, Bulk (24-Pack)	70W	2700K-5000K	120V	690	10	080083448104	Pending
ES HLC6FS1E-24P	6" Disk Light, Bulk (24-Pack)	70W	2700K-5000K	120V	970	15	080083448128	Pending

HALO SURFACE MOUNT DOWNLIGHTING

FMNL Flush Mount with Night Light FLUSH MOUNT DOWNLIGHTS - 8", 11", & 15"

- A bright fully luminous lens face and sleek edgeless design blends effortlessly into any ceiling
- Ceiling or wall mounting in compatible junction boxes or recessed housings
- 5-Color Field-SeleCCTable™ (27/30/35/40/5000K); Night Light: 2000K candlelight glow
- Includes 2 trim rings inside the box (paintable white and Matte Black)
- 5% Dimming (Phase Cut or 0-10V), 50,000 hrs, 90+ CRI



Catalog Number	Description	Finish	Replaces	Selectable CCT	Voltage	Lumens	Watts	UPC	Energy Star ID
FMNL809FS5	8-inch Flush Mount LED Downlight with Night Light*	White	70W	2700K-5000K (Downlight) 2000K (Night Light)	120V	980	10	080083312214	Pending
FMNL1112FS5	11-inch Flush Mount LED Downlight with Night Light*	White	75W	2700K-5000K (Downlight) 2000K (Night Light)	120V	1185	13	080083312238	Pending
FMNL1515FS5	15-inch Flush Mount LED Downlight with Night Light*	White	100W	2700K-5000K (Downlight) 2000K (Night Light)	120V	1540	17	080083312252	Pending

*Paintable Matte White + Matte Black trim included

SMD Square Edge SURFACE MOUNT DOWNLIGHTS - 4" & 6"

- Round or square surface mount downlight with squared edge design
- Ceiling or wall mounting in compatible junction boxes or retrofit into recessed housings
- 5 Color Field-Selectable in 27/30/35/40/5000K
- Includes LED Downlight, jbox mounting and wiring hardware, and housing retrofit kit
- 5% Dimming (Phase Cut), 50,000 hrs, 90+ CRI



Catalog Number	Description	Replaces	Selectable CCT	Voltage	Lumens	Watts	UPC	Energy Star ID
SMD4R07FS5	4" Surface Mount, Round	65W	2700K-5000K	120V	737	8	080083305667	3892052
SMD4S07FS5	4" Surface Mount, Square	65W	2700K-5000K	120V	741	8	080083305681	3892050
SMD6R07FS5	6" Surface Mount, Round	75W	2700K-5000K	120V	800	8	080083305742	3892058
SMD6S07FS5	6" Surface Mount, Square	75W	2700K-5000K	120V	710	8	080083305766	3892054
SMD4R07FS5-6PK	4" Surface Mount, Round (6-Pack)	65W	2700K-5000K	120V	737	8	080083305704	3892052
SMD4S07FS5-6PK	4" Surface Mount, Square (6-Pack)	65W	2700K-5000K	120V	741	8	080083305728	3892050
SMD6R07FS5-6PK	6" Surface Mount, Round (6-Pack)	75W	2700K-5000K	120V	800	8	080083305780	3892058
SMD6S07FS5-6PK	6" Surface Mount, Square (6-Pack)	75W	2700K-5000K	120V	710	8	080083305803	3892054

HALO SURFACE MOUNT DOWNLIGHTING

SMX Edgeless SURFACE MOUNT DOWNLIGHTS - 4", 6", 8" 14" & 18"

- A bright fully luminous lens face and sleek edgeless design blends effortlessly into any ceiling
- Ceiling or wall mounting in compatible junction boxes or recessed housings
- 6-Position Switch: 5 Color Field-Selectable (27/30/35/40/5000K) + Dim-to-Warm (3000K dims to 1800K)
- Includes j-box mounting and wiring hardware
- 5% Dimming (Phase Cut or 0-10V), 50,000 hrs, 90+ CRI



Catalog Number	Description	Replaces	Selectable CCT	Voltage	Selectable Lumens	Watts	UPC	Energy Star ID
SMX4RLSFS2W	4" Surface Mount, Round	65-90W	2700K-5000K + D2W	120V	650/800/1000	7/8/11	080083292202	3701850
SMX4SLSFS2W	4" Surface Mount, Square	65-90W	2700K-5000K + D2W	120V	650/800/1000	7/8/11	080083292189	3998744
SMX4RLSFS010	4" Surface Mount, Round (0-10V)	65-90W	2700K-5000K	120-277V	650/800/1000	7/8/11	080083292387	3998256
SMX4SLSFS010	4" Surface Mount, Square (0-10V)	65-90W	2700K-5000K	120-277V	650/800/1000	7/8/11	800083292462	3998746
SMX6RLSFS2W	6" Surface Mount, Round	75-100W	2700K-5000K + D2W	120V	750/900/1200	7/9/13	080083292240	3701854
SMX6SLSFS2W	6" Surface Mount, Square	75-100W	2700K-5000K + D2W	120V	750/900/1200	7/9/13	080083292325	3998745
SMX6RLSFS010	6" Surface Mount, Round (0-10V)	75-100W	2700K-5000K	120-277V	750/900/1200	7/9/13	080083292400	3998257
SMX6SLSFS010	6" Surface Mount, Square (0-10V)	75-100W	2700K-5000K	120-277V	750/900/1200	7/9/13	080083292486	3998747
SMX8RLSFS2W	8" Surface Mount, Round	90-120W	2700K-5000K + D2W	120V	900/1200/1500	10/12/16	080083294039	3701851
SMX8SLSFS2W	8" Surface Mount, Square	90-120W	2700K-5000K + D2W	120V	900/1200/1500	10/12/16	080083294053	N/A
SMX8RLSFS010	8" Surface Mount, Round (0-10V)	90-120W	2700K-5000K	120-277V	900/1200/1500	10/12/16	080083294077	3998259
SMX8SLSFS010	8" Surface Mount, Square (0-10V)	90-120W	2700K-5000K	120-277V	900/1200/1500	10/12/16	080083294091	N/A
SMX14RLSFS2W	14" Surface Mount, Round	90-150W	2700K-5000K + D2W	120V	1200/1600/2000	16/21/26	080083292141	N/A
SMX14SLSFS2W	14" Surface Mount, Square	90-150W	2700K-5000K + D2W	120V	1200/1600/2000	16/21/26	080083292349	N/A
SMX14RLSFS010	14" Surface Mount, Round (0-10V)	90-150W	2700K-5000K	120-277V	1200/1600/2000	16/21/26	080083292424	N/A
SMX14SLSFS010	14" Surface Mount, Square (0-10V)	90-150W	2700K-5000K	120-277V	1200/1600/2000	16/21/26	080083292509	N/A
SMX18RLSFS2W	18" Surface Mount, Round	90-150W	2700K-5000K + D2W	120V	1500/2000/2500	17/24/30	080083292165	N/A
SMX18SLSFS2W	18" Surface Mount, Square	90-150W	2700K-5000K + D2W	120V	1500/2000/2500	17/24/30	080083292363	N/A
SMX18RLSFS010	18" Surface Mount, Round (0-10V)	90-150W	2700K-5000K	120-277V	1500/2000/2500	17/24/30	080083292448	N/A
SMX18SLSFS010	18" Surface Mount, Square (0-10V)	90-150W	2700K-5000K	120-277V	1500/2000/2500	17/24/30	080083292523	N/A

HFL FLEXIBLE LINEAR TAPE - 24' & 96'

- 24' and 96' spools at 200/400 lm/ft; field cuttable every 2.5"
- High-density LED Spacing for smooth linear illumination (60 LEDs/ft)
- Eliminate dark spots with LED-integrated tape-to-tape connectors; Tape-to-Wire connects
- 5-Color Field-Selectable in 27/30/35/40/5000K
- 5% Dimming (Phase Cut LE/TE); 90+ CRI



HFL Tape (Essential Components)*

Catalog Number	Description	Selectable CCT	Voltage	Lumens	LEDs/ft	Watts/ft	UPC
HFL2001S	24' selectable CCT tape	2700K-5000K	120-277V	200	60	2.13 W/ft	080083445233
HFL4001S	24' selectable CCT tape	2700K-5000K	120-277V	400	60	2.13 W/ft	080083445257
HFL2002S	96' selectable CCT tape	2700K-5000K	120-277V	200	60	4.26 W/ft	080083445271
HFL4002S	96' selectable CCT tape	2700K-5000K	120-277V	400	60	4.26 W/ft	080083445295

*Each roll features an easy-to-apply 3M adhesive backing for quick installation.

Constant Voltage Drivers (Essential Components)

- Phase-cut (leading edge/trailing edge) or 0–10V dimming drivers, both offering smooth dimming down to 5%
- Available in two wattage options



Catalog Number	Description	Output Voltage/Max. Load	Voltage	Max. Run	Max. Run	UPC
HFLP60A	60W Phase Cut (LE/TE) Dimming Driver	24V / 60W	120V	28 ft	14 ft	080083445318
HFLP100A	100W Phase Cut (LE/TE) Dimming Driver	24V / 100W	120V	47 ft	23.5 ft	080083445332
HFLP50B	50W 0–10V Dimming Driver	24V / 50W	120-277V	23.5 ft	11.75 ft	080083445356
HFLP100B	100W 0–10V Dimming Driver	24V / 100W	120-277V	47 ft	23.5 ft	080083445370

HFL Connectors (Essential Components)

- Tape-to-tape and Tape-to-wire connectors available in multiple formats to support different installation requirements
- Tape-to-tape connectors feature integrated LEDs that eliminate dark gaps and maintain continuous illumination



Catalog Number	Description	Usability	UPC
HFL01	60" Tape-Wire+ Connector (1-pack)	Provides a 60" wire extension to connect tape light segments with spacing.	080083445554
HFL02	6" Tape-Wire+ Connector (1-pack)	Provides a 6" wire extension to connect tape light segments with spacing.	080083445578
HFL03	2" Corner+ Connector (5-pack)	Creates a clean 90° turn between tape light segments for inside or outside corners.	080083445592
HFL04	Tape-Tape Connector (5-pack)	Joins two tape light segments for straight, continuous runs.	080083445615
HFL05	Halo HFL Tape-Wire Connector (5-pack)	Connects tape light to 3-conductor low-voltage wire for gap bridging or routing around obstacles. No soldering required.	080083445639
HFL06	Halo HFL 3-Way+ Connector (5-pack)	Creates a T-junction between three tape light segments for illuminated three-direction layouts.	080083445653
HFL07	Halo HFL 4-Way+ Connector (5-pack)	Creates a four-way illuminated junction by connecting four tape light segments.	080083445677

HFL Accessories

HFL Channels

- Aluminum channels with integrated diffuse lenses creates a smooth, uniform line of light
- Enhances durability and protects LED tape
- Ideal for visible or design-forward applications
- Compatible with HFL Mounting Kits
- Mounting Kits Include 2 endcaps, 4 mounting clips, 4 screws and 4 drywall anchors



HFL Shallow Surface Mount Channels

Catalog Number	Description	UPC
HFLESS4	4' Shallow Surface Mount Lensed Channel (Shallow Surface Mount Channel Mounting Kit required)	080083445394
HFLESS8	8' Shallow Surface Mount Lensed Channel (Shallow Surface Mount Channel Mounting Kit required)	080083445417
HFLKSS*	Shallow Surface Mount Channel Mounting Kit	080083445691

*NOTE – Accessory Mounting Kit(s) required for installation – a minimum of 1 kit per 4 feet of channel (sold separately).

HFL 45° Angled Surface Mount Channels

Catalog Number	Description	UPC
HFLESA4	4' 45° Angled Surface Mount Lensed Channel (45° Angled Surface Mount Channel Mounting Kit required)	080083445479
HFLESA8	8' 45° Angled Surface Mount Lensed Channel (45° Angled Surface Mount Channel Mounting Kit required)	080083445493
HFLKA*	45° Angled Surface Mount Channel Mounting Kit	080083445738

*NOTE – Accessory Mounting Kit(s) required for installation – a minimum of 1 kit per 4 feet of channel (sold separately).

HFL Deep Surface Mount Channels

Catalog Number	Description	UPC
HFLESD4	4' Deep Surface Mount Lensed Channel (Deep Surface Mount Channel Mounting Kit required)	080083445431
HFLESD8	8' Deep Surface Mount Lensed Channel (Deep Surface Mount Channel Mounting Kit required)	080083445462
HFLKSD*	Deep Surface Mount Channel Mounting Kit	080083445714

*NOTE – Accessory Mounting Kit(s) required for installation – a minimum of 1 kit per 4 feet of channel (sold separately).

HFL Deep Recessed Lensed Channels

Catalog Number	Description	UPC
HFLERD4	4' Deep Recessed Lensed Channel (Deep Recessed Lensed Channel Mounting Kit required)	080083445516
HFLERD8	8' Deep Recessed Lensed Channel (Deep Recessed Lensed Channel Mounting Kit required)	080083445530
HFLKRD*	Deep Recessed Lensed Channel Mounting Kit	080083445752

*NOTE – Accessory Mounting Kit(s) required for installation – a minimum of 1 kit per 4 feet of channel (sold separately).

HALO RECESSED LED TRIMS

Maximum energy savings with easy installation!

- Compatible with most recessed housings and sizes
- Suitable for new construction and remodel
- Replaces traditional incandescent lighting

Quick and Easy Installation

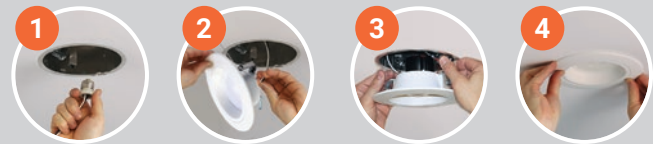

HALO RECESSED LED TRIM Product Selection Guide

	Good	Better	Best			
	MarketPro Essentials	MarketPro Essentials		MarketPro Essentials		
	DOWNLIGHTS			ADJUSTABLES		
	HLBT	LT	RL & RL Night Light	LA	RA	
FEATURES / PERFORMANCE	LED Trim Type	Slim Downlights	Downlights	Gimbal Adjustables (35° Tilt/360° Rotation)	Gimbal Adjustables (35° Tilt/360° Rotation)	
	Size & Shape	4" & 6" Round	4", 5"/6" Round	4", 5"/6" Round	3", 4", 5"/6" Round	
	Trim & Lens	Smooth Flat Lens	Baffle or Smooth w/ Flat Lens	Baffle w/ Flat Lens	Baffle w/ Flat Lens	
	Max Lumens (By size @ 3000K)	4" - 700 6" - 965	570, 645, 785	610, 900, 1,200 (Lumen Select, Dedicated) (NL: 775, 1065)	610, 635	500 (3"), 600/900 (4" & 5"/6")
	Color Temperatures (CCT)	5 CCT 27/30/35/40/5000K	5 CCT 27/30/35/40/5000K	5 CCT w/ D2W D2W/27/30/35/40/5000K (NL: 2000K)	Dedicated 3000K	5 CCT w/ D2W D2W/27/30/35/40/5000K
CONTROL	Dimming Phase Cut (LE/TE)	10%	10%	5% ¹	10%	
	Estimated Life Hours	50,000	50,000	70,000 (NL: 50,000)	35,000	
	Input Voltage	120V	120V	120V	120V	
HARDWARE	Decorative Overlays²	✓	✓ (Baffle Overlays for Baffle LT/LTEs)	✓ (Smooth & Baffle Overlays for Standard RLs)		

¹ Available in Smart Wi-Fi[®] Connected by WIZ Pro versions.

² Matte Black, Tuscan Bronze, Satin Nickel, and Paintable Matte White.

HALO RECESSED LED TRIMS

HLBT Slim LED TRIMS - 4" & 6"

- Match the look and feel of our best-selling canless fixtures, the HLB to create consistent lighting across multiple installation methods
- 5 Color Field-Selectable in 27/30/35/40/5000K
- Includes LED Trim, E26 medium socket adapter, and mounting hardware (4" - friction blades and 6" - torsion springs)
- 5% Dimming (Phase Cut LE/TE), 50,000 hrs, 90+ CRI



MarketPro Essentials

Catalog Number	Description	Replaces	Selectable CCT	Voltage	Lumens	Watts	UPC	Energy Star ID
ES HLBT407FS5	4" Slim LED Trim	60W	2700K-5000K	120V	705	7.6	080083294817	3554004
ES HLBT609FS5	6" Slim LED Trim	60W	2700K-5000K	120V	965	9.7	080083294831	3554005

RL Recessed Baffle LED TRIMS - 3", 4", & 5"/6"

- Delivers long life, exceptional performance, selectable lumens, and installs into almost any recessed housing
- Die-cast aluminum baffle trim and curved lens reduces glare and provides a traditional downlight appearance
- 6-Position Switch: 5 Color Field-Selectable (27/30/35/40/5000K) + Dim-to-Warm (3000K dims to 1800K)
- Includes LED Trim, E26 medium socket adapter, and mounting hardware (3" & 4" - friction blades and 5"/6" - torsion springs & friction blades)
- 5% Dimming (Phase Cut LE/TE), 70,000 hrs, 90+ CRI



Catalog Number	Description	Replaces	Selectable CCT	Voltage	Lumens	Watts	UPC	Energy Star ID
RL3059FSD2W1EWH	3" Baffle Trim	60W	2700K-5000K+D2W	120V	610	6.4	080083257669	2402944
RL4L59FSD2W1EWH	4" Baffle Trim	60-70W	2700K-5000K+D2W	120V	600/900 (Lumen Select)	7/11	080083257683	2402940
RL56069FSD2W1EWH	5"/6" Baffle Trim	60W	2700K-5000K+D2W	120V	700	8	080083818525	2356074
RL56LS9FSD2W1EWH	5"/6" Baffle Trim	70-75W	2700K-5000K+D2W	120V	900/1,200 (Lumen Select)	8.5/14	080083818549	2354587

LA Recessed Baffle Adjustable Gimbal LED TRIMS - 4" & 5"/6"

- Adjustable retrofit aims lighting where you want it with 360° of rotation and 35° of tilt
- Regressed dead-front plastic baffle trim for improved cutoff
- Includes LED Trim, E26 medium socket adapter, and mounting hardware (4"-friction blades; 5"/6"-torsion springs - only fits housings with spring receivers)
- 10% Dimming (Phase Cut LE/TE), 35,000 hrs, 90+ CRI



MarketPro Essentials

Catalog Number	Description	Replaces	CCT	Voltage	Lumens	Watts	UPC	Energy Star ID
ES LA4069301EWH	4" Adjustable Gimbal Trim	60W	3000K	120V	610	9	080083818143	2325616
ES LA56069301EWH	5"/6" Adjustable Gimbal Trim	60W	3000K	120V	635	9	080083818242	2325606

HALO RECESSED LED TRIMS

LT Recessed Baffle or Smooth Splay

LED TRIMS - 4" & 5"/6"

- The LT LED trims offer a cost-saving alternative to the RL Series
- Dead-front plastic fixture with either baffle or smooth splay trims and smooth flat lens
- LT** - 5 Color Field-Selectable in 27/30/35/40/5000K; **hLTE** - Dedicated in 3000K
- Includes LED Trim, E26 medium socket adapter, and mounting hardware (4" - friction blades; 5"/6" - torsion springs - only fits housings with spring receivers)
- 10% Dimming (Phase Cut LE/TE), 35,000 hrs, 90+ CRI



MarketPro Essentials Selectable 5-CCT

Catalog Number	Description	Replaces	CCT	Voltage	Lumens	Watts	UPC	Energy Star ID
ES LTSS4069FS1EWHR	4" Smooth Splay Trim	60W	2700K-5000K	120V	650	7.2	080083283989	3462891
ES LTT4069FSMBSS	4" Smooth Splay Trim, Black	60W	2700K-5000K	120V	650	7.2	080083309481	Pending
ES LT4069FS1EWHR	4" Baffle Trim	60W	2700K-5000K	120V	680	7	080083283965	2508121
ES LTT406FSMB	4" Baffle Trim, Black	60W	2700K-5000K	120V	680	7	080083309306	4437368
ES LT4099FS1EWHR	4" Baffle Trim	70W	2700K-5000K	120V	1030	9	080083284009	2508243
ES LTT409FSMB	4" Baffle Trim, Black	70W	2700K-5000K	120V	1000	9	080083309443	Pending
ES LTSS56079FS1EWHR	5"/6" Smooth Splay Trim	65W	2700K-5000K	120V	750	8.3	080083284061	3462894
ES LTT5607FSMBSS	5"/6" Smooth Splay Trim, Black	65W	2700K-5000K	120V	750	8.3	080083309504	4437372
ES LT56079FS1EWHR	5"/6" Baffle Trim	60W	2700K-5000K	120V	805	7	080083284047	2508127
ES LTT5607FSMB	5"/6" Baffle Trim, Black	60W	2700K-5000K	120V	805	7	080083309320	4437371
ES LT56129FS1EWHR	5"/6" Baffle Trim	75W	2700K-5000K	120V	1,345	12	080083284085	2508244
ES LTT5612FSMB	5"/6" Baffle Trim, Black	75W	2700K-5000K	120V	1200	12	080083309467	4437374
ES LT4069FS1EWHR4PK	4" Baffle Trim (4-Pack)	60W	2700K-5000K	120V	680	7	080083284160	3462889
ES LT56079FS1EWHR4PK	5"/6" Baffle Trim (4-Pack)	60W	2700K-5000K	120V	805	7	080083284184	3462892
ES LTT406FSMB-4PK	4" Baffle Trim (4-Pack), Black	60W	2700K-5000K	120V	680	7	080083309344	4437367
ES LT56079FS1EWHR6PK	5"/6" Baffle Trim (6-Pack)	60W	2700K-5000K	120V	805	7	080083284146	3462892
ES LTT5607FSMB-6PK	5"/6" Baffle Trim (6-Pack), Black	60W	2700K-5000K	120V	805	7	080083309528	4437370
ES LTT406FSMB-6PK	4" Baffle Trim (6-Pack), Black	60W	2700K-5000K	120V	680	7	080083309542	4437367

MarketPro Essentials Dedicated CCT & Lumens

Catalog Number	Description	Replaces	CCT	Voltage	Lumens	Watts	UPC	Energy Star ID
ES LTE46930-12PK	4" Baffle Trim (12-Pack)	60W	3000K	120V	620	8	080083285761	2856270
ES LTE46930-18PK	4" Baffle Trim (18-Pack)	60W	3000K	120V	620	8	080083285785	2856270
ES LTE566930-12PK	5"/6" Baffle Trim (12-Pack)	60W	3000K	120V	700	10	080083285808	2856271
ES LTE566930-18PK	5"/6" Baffle Trim (18-Pack)	60W	3000K	120V	700	10	080083285822	2856271

Accessories (optional)

Catalog Number	Description	Finish	UPC
LT30MW	3" Smooth Splay Overlay	Matte White	080083297528
LT40MW	4" Smooth Splay Overlay	Matte White	080083297542
LT60MW	6" Smooth Splay Overlay	Matte White	080083297566
LT30MB	3" Smooth Splay Overlay	Matte Black	080083297580
LT40MB	4" Smooth Splay Overlay	Matte Black	080083297603
LT60MB	6" Smooth Splay Overlay	Matte Black	080083297627



HALO RECESSED LED TRIMS

RA Recessed Adjustable Gimbal Baffle

LED TRIMS - 3", 4", & 5"/6"

- Adjustable retrofit aims lighting where you want it with 360° of rotation and 35° of tilt and installs in almost any recessed housing
- Regressed die-cast aluminum baffle trim reduces glare and improves cutoff
- 6-Position Switch: 5 Color Field-Selectable (27/30/35/40/5000K) + Dim-to-Warm (3000K dims to 1800K)
- Included: Adjustable LED Trim, E26 medium socket adapter, and mounting hardware (4" - friction blades; 5"/6" - torsion springs & friction blades)
- 5% Dimming (Phase Cut LE/TE), 50,000 hrs, 90+ CRI



Catalog Number	Description	Replaces	Selectable CCT	Voltage	Lumens	Watts	UPC	Energy Star ID
RA3059FSD2W1EWH	3" Adjustable Gimbal Trim	60W	2700K-5000K + D2W	120V	570	6	080083900954	2252183, 2277232
RA4LS9FSD2W1EWH	4" Adjustable Gimbal Trim	60W	2700K-5000K + D2W	120V	600/900 (Lumen Select)	6/9	080083282975	2567964
RA56LS9FSD2W1EWH	5"/6" Adjustable Gimbal Trim	60W	2700K-5000K + D2W	120V	600/900 (Lumen Select)	6/9	080083282999	2567965

HU11 LED Under Cabinet

9", 18", 24", & 36"

- Sleek, low-profile LED under cabinet with less than 1" profile
- 3 Color Field-Selectable in 27/30/4000K
- 5% Dimming (Phase Cut LE/TE), 50,000 hrs, 90+ CRI



Catalog Number	Description	Replaces	Selectable CCT	Voltage	Lumens	Watts	UPC	Energy Star ID
HU1109D9SP	9" Under Cabinet	17W INC	2700K-4000K	120V	300	5	080083875788	2341224
HU1118D9SP	18" Under Cabinet	33W INC	2700K-4000K	120V	560	8	080083875863	2341217
HU1124D9SP	24" Under Cabinet	44W INC	2700K-4000K	120V	785	11	080083875948	2341218
HU1136D9SP	36" Under Cabinet	56W INC	2700K-4000K	120V	1,125	16	080083876020	2341219

Traditional Recessed Trims

4", 5", & 6"

- Traditional recessed trims install into recessed housings, are offered in a variety of styles, and accept different lamp types
- Trims shape light to minimize glare and reduce ceiling brightness
- Open trims focus the downlighting beam to provide uniform distribution
- Can be used in new construction or remodel housings



Catalog Number	Description	Lamp Source	UPC
4001WB	4" Step Baffle - Plastic	Halogen, INC, LED, CFL	080083745869
993W	4" Coilex Baffle	Halogen, INC, LED, CFL	080083628483
5125WB	5" Full Cone Baffle	Halogen, INC, LED, CFL	080083743162
300P	6" Open - Socket Supporting	Halogen, INC, LED, CFL	662400302421
30WAT	6" Air-Tite Baffle	Halogen, INC, LED, CFL	662400603320
310W	6" Coilex Baffle	Halogen, INC, LED, CFL	080083515882
6100WB	6" Tapered Metal Baffle, 2-Rings Narrow & Wide	Halogen, INC, LED, CFL	080083743452
6125WB	6" Full Cone Baffle	Halogen, INC, LED, CFL	080083754465

HALO HOUSINGS

HALO Housing Pallet

HALO Housing Pallet quantities are quick, convenient and easy to order.

H Series Housings - 4" & 6"

The industry standard recessed housing for commercial and residential applications.

- Ideal for commercial and residential applications
- Compatible with recessed LED trims or E26 socket-based lamps (bulbs)
- Optimized and listed for EISA compliant tungsten-halogen lamps along with incandescent, CFL, and LED lamps with E26 bases
- For installation in insulated contact (IC) and non-IC rated ceilings
- Available in 120V or 120-277V configurations



MarketPro Essentials LED Housings

Catalog Number	Description	Connection	Voltage	Pallet Quantity	UPC
ES H245ICAT	4" LED Ultra-Shallow New Construction (No Socket)	LED Quick Connect	120-277V	180 (30 cartons)	080083770717
ES H245RICAT	4" LED Ultra-Shallow Remodel (No Socket)	LED Quick Connect	120-277V	432 (72 cartons)	080083756520
ES H995ICAT	4" LED New Construction (No Socket)	LED Quick Connect	120-277V	144 (24 cartons)	080083616930
ES H2550ICAT	5" LED Shallow New Construction (No Socket)	LED Quick Connect	120-277V	192 (32 cartons)	080083310319
ES H2750ICAT	6" LED Shallow New Construction (No Socket)	LED Quick Connect	120-277V	192 (32 cartons)	080083618170
ES H750ICAT	6" LED New Construction (No Socket)	LED Quick Connect	120-277V	144 (24 cartons)	623961872655
ES H750ICAT-DFE	6" LED New Construction (Truckload=48 Pallets, 6912 units)	LED Quick Connect	120-277V	144 (24 cartons)	623961872655

MarketPro Essentials Traditional Housings

Catalog Number	Description	Connection	Voltage	Pallet Quantity	UPC
ES H99ICAT	4" New Construction	E26 Socket	120V	144 (24 cartons)	080083582259
ES H7ICAT	6" New Construction	E26 Socket	120V	144 (24 cartons)	080083609628
ES H7ICATNB	6" New Construction (No Socket Bracket)	E26 Socket	120V	144 (24 cartons)	662400612032
ES H7ICAT-DFE	6" New Construction (Truckload=48 Pallets, 6912 units)	E26 Socket	120V	144 (24 cartons)	080083609628
ES H7RICAT-DFE	6" Remodel (Truckload=48 Pallets, 6912 units)	E26 Socket	120V	144 (24 cartons)	662400610588
ES H4ICATSB-DFE	4" New Construction (Truckload=48 Pallets, 6912 units)	E26 Socket	120V	144 (24 cartons)	080083307682

HALO WIZ SMART WI-FI® LIGHTING



HALO is now available with WiZ and Matter!

Illuminate spaces with the perfect lighting. Our Circadian Rhythm follows the sun-starting with energizing light in the morning to help you focus, and transitioning to warmer light in the evening.

Introducing Matter, which allows you to control your WiZ fixtures from more than one smart platform, providing ultimate flexibility and an Open Platform.



RL Smart Wi-Fi® Baffle

CANLESS LED DOWNLIGHTS (Connected by WiZ Pro) - 4" & 6"

- Set up with the WiZ app to wirelessly control lighting
- Fixtures provide 16 million colors and tunable white light from 2200-6500K
- Die-cast aluminum baffle trim reduces glare
- Includes LED downlight and remote driver/junction box with mounting bar
- Wi-Fi® Control & Dimming to 5% via WiZ app, 50,000 hrs, 90+ CRI



Catalog Number	Description	Finish	Light Output	Voltage	Lumens	Watts	UPC	Energy Star ID
RLWZC409	4" Smart Baffle Canless Downlight (WiZ Pro)	White	Full Color & Tunable White (2200-6500K)	120V	900	10	080083298006	3626861
RLWZC612	6" Smart Baffle Canless Downlight (WiZ Pro)	White	Full Color & Tunable White (2200-6500K)	120V	1,200	13	080083298020	3626862

RA Smart Wi-Fi® Baffle

CANLESS LED DOWNLIGHTS (Connected by WiZ Pro) - 4" & 6"

- Set up with the WiZ app to wirelessly control lighting
- Fixtures provide 16 million colors and tunable white light from 2200-6500K
- Die-cast aluminum baffle trim reduces glare
- Includes LED downlight and remote driver/junction box with mounting bar
- Wi-Fi® Control & Dimming to 5% via WiZ app, 50,000 hrs, 90+ CRI



Catalog Number	Description	Finish	Light Output	Voltage	Lumens	Watts	UPC	Energy Star ID
RAWZC409	4" Smart Adjustable Canless Downlight (WiZ Pro)	White	Full Color & Tunable White (2200-6500K)	120V	900	10.8	080083297863	3626859
RAWZC610	5" / 6" Smart Adjustable Canless Downlight (WiZ Pro)	White	Full Color & Tunable White (2200-6500K)	120V	1,000	10.8	080083297887	3626860

HLB Smart Wi-Fi® Slim

CANLESS LED DOWNLIGHTS (Connected by WiZ Pro) - 4" & 6"

- Set up with the WiZ app to wirelessly control lighting
- Fixtures provide 16 million colors and tunable white light from 2200-6500K
- Dead-front plastic frame and smooth lens
- Includes LED downlight and remote driver/junction box with mounting bar
- Wi-Fi® Control & Dimming to 5% via WiZ app, 50,000 hrs, 90+ CRI

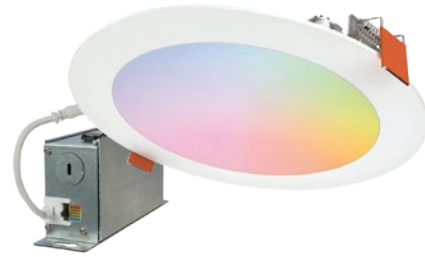

Catalog Number	Description	Replaces	Light Output	Voltage	Lumens	Watts	UPC	Energy Star ID
HLB4069WZRGBWMWR	4" Smart Slim Canless Downlight (WiZ Pro)	60W	Full Color & Tunable White (2200-6500K)	120V	600	9	080083255955	2408244
HLB6099WZRGBWMWR	6" Smart Slim Canless Downlight (WiZ Pro)	70W	Full Color & Tunable White (2200-6500K)	120V	960	12	080083255931	2408245

RL Dual Zone Smart Wi-Fi® Recessed Baffle

CANLESS LED DOWNLIGHTS (Connected by WiZ Pro) - 4" & 6"

- 2 Zones: Downlight and Outer Ring – both with 16 million colors and tunable white light from 2200-6500K
- Set up with the WiZ app to wirelessly control lighting
- Die-cast aluminum baffle trim reduces glare
- Includes LED downlight and remote driver/junction box with mounting bar
- Wi-Fi® Control & Dimming to 5% via WiZ app, 50,000 hrs, 90+ CRI



Catalog Number	Description	Replaces	Light Output	Voltage	Lumens	Watts	UPC	Energy Star ID
RLWZDZC4	4" Smart Dual Zone Canless Downlight (WiZ Pro)	65W	Full Color & Tunable White (2200-6500K)	120V	700	8	080083296897	3892085
RLWZDZC6	6" Smart Dual Zone Canless Downlight (WiZ Pro)	70W	Full Color & Tunable White (2200-6500K)	120V	1000	10	080083297115	3892086

RL Dual Zone Smart Wi-Fi® Recessed Baffle

LED TRIMS (Connected by WiZ Pro) - 4" & 5"/6"

- 2 Zones: Downlight and Outer Ring – both with 16 million colors and tunable white light from 2200-6500K
- Set up with the WiZ app to wirelessly control lighting
- Die-cast aluminum baffle trim reduces glare
- Includes LED Trim, E26 medium socket adapter, and mounting hardware (4" - friction blades and 5"/6" - torsion springs & friction blades)
- Wi-Fi® Control & Dimming to 5% via WiZ app, 50,000 hrs, 90+ CRI



Catalog Number	Description	Replaces	Light Output	Voltage	Lumens	Watts	UPC	Energy Star ID
RLWZDZT4	4" Smart Dual Zone LED Trim (WiZ Pro)	65W	Full Color & Tunable White (2200-6500K)	120V	750	7	080083297139	3892088
RLWZDZT56	5"/6" Smart Dual Zone LED Trim (WiZ Pro)	70W	Full Color & Tunable White (2200-6500K)	120V	1000	10	080083297153	3892089

RL Smart Wi-Fi® Recessed Baffle

LED TRIMS (Connected by WiZ Pro) - 4" & 5"/6"

- Set up with the WiZ app to wirelessly control lighting
- Fixtures provide 16 million colors and tunable white light from 2200-6500K
- Die-cast aluminum baffle trim reduces glare
- Includes LED Trim, E26 medium socket adapter, and mounting hardware (4" - friction blades and 5"/6" - torsion springs & friction blades)
- Wi-Fi® Control & Dimming to 5% via WiZ app, 50,000 hrs, 90+ CRI



Catalog Number	Description	Replaces	Light Output	Voltage	Lumens	Watts	UPC	Energy Star ID
RL4069WZRGBWWHR	4" Smart Baffle LED Trim (WiZ Pro)	70W	Full Color & Tunable White (2200-6500K)	120V	615	8	080083256167	2397256
RL56069WZRGBWWHR	5"/6" Smart Slim Canless Downlight (WiZ Pro)	90W	Full Color & Tunable White (2200-6500K)	120V	690	8	080083256143	2397259

ESF Smart Wi-Fi® Flood & Motion

OUTDOOR SECURITY (Connected by WiZ Pro)

- Set up with the WiZ app to wirelessly control lighting
- Fixtures provide 16 million colors and tunable white light from 2200-6500K
- Includes LED floodlight with sleek design, motion activated models available
- Wi-Fi® Control & Dimming to 5% via WiZ app, 50,000 hrs, wet-location rated, 88 CRI



Catalog Number	Description	Replaces	Finish	Light Output	Voltage	Lumens	Watts	UPC	Energy Star ID
ESF2ARGBWF-B-WiZ	Twin Head Smart Wi-Fi Floodlight (WiZ Pro)	150W	Black	Full Color & Tunable White (2200-6500K)	120V	2,235	29	080083260300	Pending
ESF2ARGBWF-W-WiZ	Twin Head Smart Wi-Fi Floodlight (WiZ Pro)	150W	White	Full Color & Tunable White (2200-6500K)	120V	2,445	29	080083260324	Pending
ESF2ARGBWM-B-WiZ	Twin Head Smart Wi-Fi Floodlight (WiZ Pro), Motion	150W	Black	Full Color & Tunable White (2200-6500K)	120V	2,400	29	080083260348	Pending
ESF2ARGBWM-W-WiZ	Twin Head Smart Wi-Fi Floodlight (WiZ Pro), Motion	150W	White	Full Color & Tunable White (2200-6500K)	120V	2,400	29	080083260362	Pending

WiZ Controls

ROOM CONTROLLERS, SWITCHES & DIMMERS (Connected by WiZ Pro)

- Wireless control of connected WiZ lighting (no hub needed)
- Room Controller supports dynamic lighting control (On/Off/Dimming/White Tuning/ 4 Scenes)
- Dimmer and Switch controls traditional non-smart loads



Catalog Number	Description	Finish	Voltage	UPC
CWW-TW-SCENE-WH	Smart Wi-Fi® Room Controller	White	120V	080083457489
CWR-TW-SCENE-WH	Smart Wi-Fi® Remote Room Controller	White	Battery (4AAA)	850047503121
SWW-SWT-WH	Smart Wi-Fi® ON/OFF Switch (for non-smart loads)	White	120V	850047503060
SWW-DIM-WH	Smart Wi-Fi® Dimmer (for non-smart loads)	White	120V	850047503053





Flat Panels



Troffers

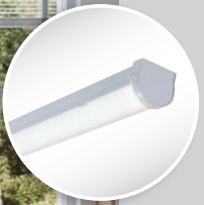

Strip Lights



Wraps

Metalux

COMMERCIAL LED LIGHTING

Metalux Commercial features a wide selection of affordable yet aesthetically pleasing fixtures with an expanded offering of selectable color temperatures and lumen options.

METALUX FLAT PANELS

CGTS | CGT Series FLAT PANEL

- Affordable contractor LED panel with fixed or selectable configurations
- Fits in shallow plenums with room to spare; Thin 2 1/8 - inch height
- Field Selectable CCT and Lumens
- Ideal for office spaces, education, healthcare and retail merchandising
- Optional: Wireless integrated sensors provide standalone operation that meets code compliance with simple set up via the Wavelinx mobile app
- Optional: 8W emergency battery packs installed

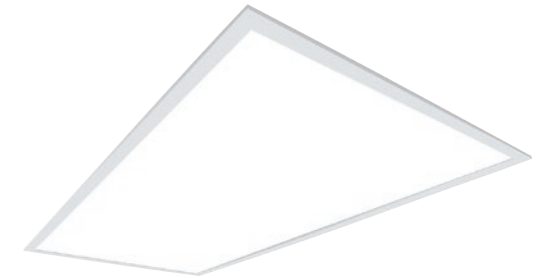

MarketPro Essentials Selectable CCT & Lumens

Catalog Number	Description	Replaces	CCT	Voltage	Lumens	Watts	UPC	DLC Product ID
ES 14CGTS-L3C3	1'x4' Recessed Panel	2-T8	3500K-5000K	120-277V	2,600-4,800	20/29/34	080083282517	S-3EJHF2
ES 22CGTS-L3C3	2'x2' Recessed Panel	3-T8 17W, 2-U6T8	3500K-5000K	120-277V	2,800-4,700	19/28/32	080083194728	PL74TQBZR6SL
ES 24CGTS-L3C3	2'x4' Recessed Panel	4-T8 32W	3500K-5000K	120-277V	4,200-7,200	29/42/51	080083194704	PL0ULJMKXBCH

MarketPro Essentials Dedicated CCT & Lumens

Catalog Number	Description	Replaces	CCT	Voltage	Lumens	Watts	UPC	DLC Product ID
ES 22CGT3540C	2'x2' Recessed Panel	3-T8	4000K	120-277V	3,582	32	080083880027	POYGNM7S
ES 24CGT4540C	2'x4' Recessed Panel	2-T8, 3-T8	4000K	120-277V	4,432	38	080083880102	PLTEVMIJ

CGTS with Wavelinx LITE

Catalog Number	Description	Replaces	CCT	Voltage	Selectable Lumens	Watts	UPC	DLC Product ID
14CGTS-L3C3-WLS	1'x4' Recessed Panel with WaveLinX LITE	2-T8	3500K-5000K	120-277V	2,600-4,800	20/29/34	080083306015	S-RFBM0G
22CGTS-L3C3-WLS	2'x2' Recessed Panel with WaveLinX LITE	3-T8 17W, 2-U6T8	3500K-5000K	120-277V	2,800-4,700	19/28/32	080083306022	S-KTBZC8
24CGTS-L3C3-WLS	2'x4' Recessed Panel with WaveLinX LITE	4-T8 32W	3500K-5000K	120-277V	4,200-7,200	29/42/51	080083306039	S-6DLPMV

Note: DLC Premium items are noted in bold.

CGTS with Emergency Battery Packs

Catalog Number	Description	Replaces	CCT	Voltage	Selectable Lumens	Watts	UPC	DLC Product ID
14CGTS-L3C3-EL8W	1X4 CGTS 8W w/Emer. Battery Backup	2-T8	3500K-5000K	120-277V	2,600-4,700	20/29/34	080083306046	S-RFBM0G
22CGTS-L3C3-EL8W	2X2 CGTS 8W w/Emer. Battery Backup	3-T8 17W, 2-U6T8	3500K-5000K	120-277V	2,800-4,600	19/28/32	080083306053	S-KTBZC8
24CGTS-L3C3-EL8W	2X4 CGTS 8W w/Emer. Battery Backup	4-T8 32W	3500K-5000K	120-277V	4,200-7,200	29/42/51	080083306060	S-6DLPMV

FPS Series FLAT PANEL

- Ultra-thin LED flat panel; Less than 2-inches height for shallow plenums
- 3 Color Field-Selectable in 30/35/4000K
- Selectable switch to set color temperature, lumens and watts desired for task
- Refined visual optics, superior acrylic light guide; uniform corner to corner illumination
- Ideal for office spaces, schools, healthcare facilities and retail merchandising areas



Catalog Number	Description	Replaces	Selectable CCT	Voltage	Selectable Lumens	Watts	UPC	DLC Product ID
14FPSL1SCT3	1'x4' Recessed Panel	2-T8	3000K-4000K	120-277V	2,000-4,100	18/27/36	080083889440	PYJV3ZJZ
22FPSL2SCT3	2'x2' Recessed Panel	3-T8	3000K-4000K	120-277V	1,700-3,500	15/22/31	080083889402	PB32RP9H
24FPSL2SCT3	2'x4' Recessed Panel	2-T8, 3-T8	3000K-4000K	120-277V	3,100-6,300	27/40/56	080083889365	PZFJCMXS

METALUX FLAT PANELS

Multi-Mount Selectable FLAT PANEL

- Visually comforting panel mounts directly to the ceiling or wall reducing labor and material cost by removing the need for a surface mount kit
- Versatile mounting allows for surface, wall, recessed, or suspended with kit
- Selectable Color Temperatures in 90 CRI Standard:
2x2/2x4/1x4: 35/40/5000K | 4' x 6': 27/30/35/40/5000K
- Selectable Lumens: Low, Medium, High settings
- Ideal choice for commercial office, school, and healthcare spaces



Catalog Number	Description	Replaces	Selectable CCT	Voltage	Selectable Lumens	Watts	UPC	DLC Product ID
4MMS6-L3C5-UNV	4'x6", Direct Mount Panel	2-T8 32W	2700K-5000K	120-277V	1,680-3,000	19/25/33	080083292028	S-KJX1CZ
22MMS-L3C3-UNV	2'x2", Direct Mount Panel	3-T8 32W	3500K-5000K	120-277V	2,400-4,800	21/28/42	080083292042	S-KJX1CZ
24MMS-L3C3-UNV	2'x4", Direct Mount Panel	4-T8 32W	3500K-5000K	120-277V	3,500-6,200	28/36/48	080083292059	S-V9CG2Y
14MMS-L3C3-UNV	1'x4", Direct Mount Panel	2-T8 32W	3500K-5000K	120-277V	2,620-5,286	18/25/38	080083292035	S-28RRZT

Y-hanger Suspension Cable Kit FLAT PANEL

Y-hanger suspension cable kit with carabiner, SO cord, connectors and round 4" J-box cover plate

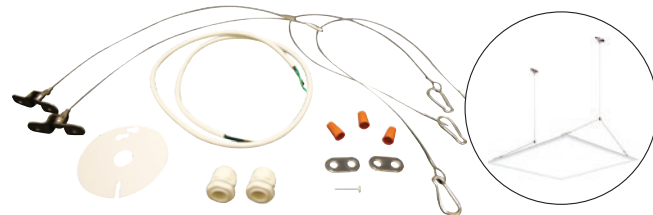

Catalog Number	Description	UPC
FPSUS24	Y-hanger suspension cable kit	080083258895

CGRK Retrofit Kit FLAT PANEL

- Luminaire panels and mounting rails shipped separately for quick installation
- 3 Color Field-Selectable in 35/40/5000K with three lumen options for various retrofit applications
- Micro-optics for uniform illumination, extruded aluminum frame for performance and aesthetics
- DLC Premium options for maximum energy savings and rebates, including WaveLinx Lite for enhanced savings



Catalog Number	Description	Replaces	Selectable CCT	Voltage	Selectable Lumens	Watts	UPC	DLC Product ID
14CGRK-L3C3-UNV-MP4	1'x4' Backlit Panel Retrofit Kit (4-Pack)	2-T8	3500K-5000K	120-277V	2,000-4,100	14/22/29	080083312139	S-XP62Y7
22CGRK-L3C3-UNV-MP4	2'x2' Backlit Panel Retrofit Kit (4-Pack)	3-T8 17W, 2-U6T8	3500K-5000K	120-277V	2,000-4,100	15/22/29	080083312146	S-W4YPLT
24CGRK-L3C3-UNV-MP4	2'x4' Backlit Panel Retrofit Kit (4-Pack)	4-T8 32W	3500K-5000K	120-277V	2,800-5,000	20/27/35	080083312153	S-871T6V

METALUX TROFFERS

Surround Frame Selectable ILLUMINATED FRAME

- Architectural 1.5" illuminated modern frame enhances the look of any space
- Versatile mounting in existing T-grid using ceiling tile as the reflector, suspension also available with kit
- 4 Color Field-Selectable in 30/35/40/5000K
- Selectable Lumens - Low, Medium, High settings
- Ideal choice for commercial office, school, and healthcare spaces



Catalog Number	Description	Replaces	Selectable CCT	Voltage	Selectable Lumens	Watts	UPC	DLC Product ID
22SFS-L3C4-UNV	2'x2', Surround Frame	3-T8 32W	3000K-5000K	120-277V	1,900-4,600	15/25/36	080083293124	S-6WZ2T
24SFS-L3C4-UNV	2'x4', Surround Frame	4-T8 32W	3000K-5000K	120-277V	3,000-6,000	23/35/47	080083293148	S-TPM2HQ

Note: DLC Premium items are noted in bold.

Cruze Selectable CZS | Cruze ST Recessed TROFFER

- Architectural center basket lens troffer with aesthetic appeal
- Latch-less design provides clean architectural look; ribbed, frosted acrylic lens
- 3 Color Field-Selectable in 30/35/4000K and dedicated in 3500K, 4000K
- Ideal choice for commercial, institutional and healthcare facilities



Catalog Number	Description	Replaces	Selectable CCT	Voltage	Selectable Lumens	Watts	UPC	DLC Product ID
14CZSCT3-UNV	1'x4', Troffer	2-T8	3000K-4000K	120-277V	3,000-4,400	20-30	080083268443	S-5LPE0V
22CZSCT3-UNV	2'x2', Troffer	2-T5, 2-T8	3000K-4000K	120-277V	2,700-4,075	21-31	080083268467	S-QDP2J8
24CZSCT3-UNV	2'x4', Troffer	2-T8, 3-T8	3000K-4000K	120-277V	3,500-6,500	24-47	080083268481	S-MW0TCN

Achieva™ Recessed Selectable TROFFER

- Ultra slim 1.5" center basket design fits into the shallowest of plenums
- 3 Color Field-Selectable in 30/35/4000K in 80+ CRI
- 3 Selectable lumens in standard or HO options up to 8,150
- Ideal choice for commercial, institutional and healthcare facilities



MarketPro Essentials

Catalog Number	Description	Replaces	Selectable CCT	Voltage	Selectable Lumens	Watts	UPC	DLC Product ID
ES 14ARS-L3C3-UNV	1'x4', Troffer	2-T8	3500K-5000K	120-277V	2,800-4,600	20/26/33	080083282241	S-N7LRJL
ES 22ARS-L3C3-UNV	2'x2', Troffer	2-T8, 2-T5	3500K-5000K	120-277V	2,750-4,300	20/26/33	080083282128	S-N0X10I
ES 24ARS-L3C3-UNV	2'x4', Troffer	2-T8, 3-T8	3500K-5000K	120-277V	3,400-6,250	24/33/46	080083282005	S-EA9S16
ES 24ARS-L3C3-UNV-MP2	2'x4', Troffer (2-Pack)	2-T8, 3-T8	3500K-5000K	120-277V	3,400-6,250	24/33/46	080083282364	S-EA9S16

Note: DLC Premium items are noted in bold.

METALUX STRIP LIGHTS | WRAPS

SLSTP Series STRIP LIGHT

- LED strip light with decorative end caps and toolless lens removal
- Suitable for either single or continuous row application
- 3 Color Field-Selectable in 35/40/5000K and dedicated in 4000K
- Field-Selectable lumens 2,400 - 11,200 or dedicated up to 9300
- Impact resistant polycarbonate lens reduces maintenance



Catalog Number	Description	Replaces	Selectable CCT	Voltage	Selectable Lumens	Watts	UPC	DLC Product ID
2SLSTPSC-UNV	2' Single Lens	2-T8 17W	3500K-5000K	120/277V	2,500	22	080083174409	S-YBI5XF
4SLSTPSC-UNV	4' Single Lens	2-T8 32W, 1-T5HO 54W	3500K-5000K	120/277V	2,400-6,000	18-46	080083174416	S-OICHU8
8SLSTPSC-UNV	8' Single Lens	4-T8 32W, 2-T12 75W	3500K-5000K	120/277V	4,300-11,200	33-85	080083174423	S-7SKGJW
4SLSTP4040DD-UNV	4' Single Lens	2-T8 32W, 1-T5HO 54W	4000K (dedicated)	120/277V	5,200 (Dedicated)	39	080083705825	PXZQGN9C

Sensor Kits

Catalog Number	Description	PIR Sensor	UPC
SLSTP MS00 KIT	SLSTP Field Installable Sensor KIT	100%/50% / OFF	080083254200
SLSTP MS25 KIT	SLSTP Field Installable Sensor KIT	100%/50% / Low (~30%)	080083254224

ST Series STRIP LIGHT

- Full-length LED strip light ideal for replacing fluorescent strips
- Superior performance with lumens up to 9,300 and 129 lumens per watt
- 3 Color Field-Selectable in 35/40/5000K
- Continuous row mount aligner included to add-on length as needed
- Low voltage 0-10V dimming to 10%



MarketPro Essentials

Catalog Number	Description	Replaces	Selectable CCT	Voltage	Lumens	Watts	UPC	DLC Product ID
ES 2ST2L20SC3	2' Dual Lens, Dimming	2-T8 17W	3500K-5000K	120-277V	2,300	19	080083241569	S-UQ028D
ES 4ST2L40SC3	4' Dual Lens, Dimming	2-T8 32W, 1-T5HO 54W	3500K-5000K	120-277V	4,800	41	080083241583	S-TSP41D
ES 8ST2L80SC3	8' Dual Lens, Dimming	4-T8 32W, 2-T12 75W	3500K-5000K	120-277V	9,300	74	080083242207	S-5J2ZA0

WP Series WRAP

- Compact LED wrap light delivers value and energy savings
- Perfect retrofit solution for replacing single or 2-lamp fluorescent wraparounds
- Low-profile, highly versatile design; Post-painted die-formed channel
- Prismatic lens ensures even, glare-free light distribution



MarketPro Essentials

Catalog Number	Description	Replaces	CCT	Voltage	Lumens	Watts	UPC
ES 4WP3040R	4' Utility Wrap	2-T8 32W	4000K (dedicated)	120-277V	4010 (dedicated)	34	080083847167



METALUX WRAPS

ProWrap Series WRAP

- 8.8" and 14.8" wide low profile LED wraparound
- 5 Color Field-Selectable in 30/35/40/45/5000K, Field-Selectable lumens: 2,000 - 8,000
- Classic 2" low-profile lens with microprism design
- Removable KO for end conduit or thru-wire power feed



Catalog Number	Description	Replaces	Selectable CCT	Voltage	Selectable Lumens	Watts	UPC	DLC Product ID
4PWM-2060C5	4' ProWrap 8.8" Wide	2-T8 32W	3000K-5000K	120-277V	2,000-6,000	15-48W	080083470457	Pending
4PWW-4080C5	4' ProWrap 14.8" Wide	4T8 32W or 2T5HO 54W, 250MH	3000K-5000K	120-277V	4,000-8,000	30-62W	080083470471	Pending

Achieva™ Surface Selectable WRAP

- Ideal for replacing up to four lamp low-bay linear fluorescents
- 3 Color Field-Selectable in 35/40/5000K, Field-Selectable lumens: 2,250 - 12,500
- Designed for single or continuous row mount
- Suitable for ceiling, wall, or suspension mounting



Catalog Number	Description	Replaces	Selectable CCT	Voltage	Selectable Lumens	Watts	UPC	DLC Product ID
2AWS-L3C3-UNV	2' Narrow Modern Wrap, Dimming	2-T8 17W	3500K-5000K	120-277V	2,250-3,084	18/21/25	080083281244	S-LXMBTS
4AWS-L3C3-UNV	4' Narrow Modern Wrap, Dimming	2-T8 32W	3500K-5000K	120-277V	4,095-5,916	31/38/46	080083281602	S-QV8V88
8AWS-L3C3-UNV	8' Narrow Modern Wrap, Dimming	2-T8 96W, 4-T8 32W	3500K-5000K	120-277V	7,845-12,019	54/71/83	080083281800	S-864B60
2AWS-L3C3-UNV	2' Wide Modern Wrap, Dimming	3-T8 17W	3500K-5000K	120-277V	2,313-3,170	18/21/25	080083281541	S-8BS41V
4AWS-L3C3-UNV	4' Wide Modern Wrap, Dimming	3-T8 32W	3500K-5000K	120-277V	4,254-6,013	31/38/47	080083281701	S-2PPZXM
8AWS-L3C3-UNV	8' Wide Modern Wrap, Dimming	3-T8 96W, 6-T8 32W	3500K-5000K	120-277V	8,296-12,554	57/74/85	080083281909	S-0R1G6X

NWS Series WRAP

- Ideal for replacing two or three lamp fluorescents up to 96W
- 3 Color Field-Selectable in 35/40/5000K
- Field-Selectable lumens: 2,000 - 5,272
- Surface (wall or ceiling) mount via junction box or direct to surface



Catalog Number	Description	Replaces	Selectable CCT	Voltage	Selectable Lumens	Watts	UPC	DLC Product ID
2NWS3C3-UNV	2' Wrap, Dimming	2-T8 17W	3500K-5000K	120-277V	2,009-2,679	15/18/21	080083257485	S-PKU0E2
4NWS3C3-UNV	4' Wrap, Dimming	3-T8 32W	3500K-5000K	120-277V	3,300-4,800	28/32/39	080083257522	S-YJTA0N
4NWS3C3MS-UNV	4' Wrap, Dimming, Sensor *	3-T8 32W	3500K-5000K	120-277V	3,675-5,016	28/32/38	080083257607	S-2V0NL5

* Includes integrated microwave motion sensor (MS) option.

WNLED Series WRAP

- Utility commercial LED linear wrap
- Single or continuous row applications
- Frosted lens offers best-in-class uniform illumination
- Minimizes maintenance common with traditional fluorescents



Catalog Number	Description	Replaces	CCT	Voltage	Lumens	Watts	UPC	DLC Product ID
4WNLED-LD4-40SL-F-UNV-L840-CD1-U	4' Linear Wrap	2-T12, 2-T8 32W	4000K	120/277V	4,006	30	080083756889	PK3W95DW



High Bays

Vaportites

Metalux

INDUSTRIAL LIGHTING

Metalux Industrial offers a selection of economical and energy-efficient high-bay and vaportite lighting solutions designed for a wide variety of applications.

METALUX HIGH BAYS

UHBS2 High Performance LED HIGH BAY

- Durable, 12", 14", and 20" round die cast aluminum housing
- Field selectable distribution - Narrow, Medium, or Wide
- Up to 60,000 selectable lumens with 5 Color Selectable CCT - 30/35/40/50/6500K
- Sensor ready port for quick plug and play install
- 120-347V input, 0-10V dimming with 6kV surge protection



Catalog Number	Description	Replaces	Selectable CCT	Voltage	Selectable Lumens	Watts	UPC	DLC Product ID
UHBS2-1218-MV-L8C5-U	Round, White	4-T5HO 54W, 400W MH	3000K-6500K	120-347V	12,000-18,000	79-122W	080083301836	S-DVZ2KB
UHBS2-2436-MV-L8C5-U	Round, White	8-T5HO 54W, 10T8 32W, 750MH	3000K-6500K	120-347V	24,000-36,000	153-239W	080083301843	S-JVQHNC
UHBS2-4860-MV-L8C5-U	Round, White	1000W MH, 400MH	3000K-6500K	120-347V	48,000-60,000	311-388	080083301850	Pending

Note: DLC Premium items are noted in bold.

SPHB Selectable Series HIGH BAY

- 2 Compact, lightweight designs for easy install
- Up to 36,000 selectable lumens and 4000K/5000K selectable CCT
- Sensor Ready port for quick plug and play install
- Great for industrial, manufacturing, gymnasium, and warehouse



Selectable lumen output and color temperature with an easy to access toggle switch.



MarketPro Essentials

Catalog Number	Description	Replaces	Selectable CCT	Voltage	Selectable Lumens	Watts	UPC	DLC Product ID
ES SPHB-1224SE-M-UNV-L84050-CD-SP1-U	Med. Distr	6-T5HO, 8-T8, 400W MH	4000K-5000K	120-277V	12,000-24,000	82/123/166	080083289264	S-01PR4D
ES SPHB-2436SE-M-UNV-L84050-CD-SP1-U	Med. Distr	8-T5HO, 10-T8, 400W MH	4000K-5000K	120-277V	24,000-36,000	162/209/251	080083289288	S-7V2YTC

Catalog Number	Description	UPC
Y-TOGGLE-10-2PK	Mounting Toggle and 10' Cable	080083259557
Y-TOGGLE-30-2PK	Mounting Toggle and 30' Cable	080083259571

Note: DLC Premium items are noted in bold.

HBS1 Sensor HIGH BAY

- Simple, in-field plug and play installation; Occupancy control with 4 preset modes
- Auto-disconnect technology during EM battery operation
- Passive Infra-Red (PIR) and daylight sensor with detection at mounting heights up to 50FT
- Remote control capability using separate accessory (HBS Sensor Remote Control)



Catalog Number	Description	UPC
HBS1*	PIR Sensor 360 Lens 50FT MH Kit	080083257898
HBS SENSOR REMOTE	HBS Sensor Remote Control	080083260249

*To meet state and local codes, EBP cannot be used with HBS with sensor or with HBS sensor accessory.

WaveLinx Sensor HIGH BAY

- Models suitable for High bay (up to 40ft) applications
- Out of the box functionality: Occupied to Full, Unoccupied to off, daylighting disabled
- Passive Infra-Red (PIR) motion sensor; Integrated photocell for daylight harvesting



Catalog Number	Description	UPC
WLS4-HB2	WaveLinx LITE Industrial Fixture Mount High Bay Sensor, White, 15 - 40ft (4.5 - 12.2m)	080083446315

METALUX HIGH BAYS | VAPORTITES

EZBY Series HIGH BAY

- Up to 30,000 selectable lumens and 3000/4000/5000K selectable CCT
- Sensor ready port for quick plug and play install
- Mounting ring included for rapid install
- 120-347V input, 0-10V dimming



MarketPro Essentials

Catalog Number	Description	Replaces	Selectable CCT	Voltage	Selectable Lumens	Watts	UPC	DLC Product ID
ES EZBY-1830C3-MV-BLK	Round, Black	8 T8 or 6 T5HO lamps or 400W MH	3000K-5000K	120-347V	18,000-30,000	122-185W	080083305889	S-WK156D

Note: DLC Premium items are noted in bold.

APVT Series VAPORTITE

- Durable polycarbonate housing with integral metal gear tray
- 4ft and 8ft sizes with CCT and lumen select capability
- UL Wet location, IP65 and operating temp -20C to 40C
- Stainless steel latches, single conduit hub, and mounting included



MarketPro Essentials

Catalog Number	Description	Replaces	Selectable CCT	Voltage	Selectable Lumens	Watts	UPC	DLC Product ID
ES 4APVTLD-SL3C3	4' Selectable Output	3-T8 32W, 2-T5HO 54W	3500K-5000K	120-277V	3,000-6,000	21-46	080083264216	S-M39BJL
ES 8APVTLD-SL3C3	8' Selectable Output	4-T8 32W, 3-T5HO 54W	3500K-5000K	120-277V	8,500-12,000	59-94	080083266333	S-3EH2VC



METALUX HIGH BAYS



		MarketPro Essentials	MarketPro Essentials	
		EZBY	SPHB	UHBS2
APPLICABILITY ¹	Big Box Retail	★	★★	★★
	Sports / Recreation	★	★★	★★
	Warehouses	★★★	★★★	★★★
	Manufacturing	★★	★★★	★★★
	Cold Storage	★★	★★★	★★
	Complex Environments	★	★	★★

		MarketPro Essentials	MarketPro Essentials	
FEATURES / PERFORMANCE	Lumen Range	18,000 - 28,000	12,000 - 36,000	12,000 to 60,000
	Selectable Lumens	18,000-30,000	12,000 - 24,000 or 24,000 - 36,000	12,000-18,000, 24,000-36,000, and 48,000-60,000
	Efficacy (Max)	150 lm/W	158 lm/W	181 lm/W
	CRI	80	80	80
	Distribution	Medium (100-deg)	M	Selectable Optics (N, M, or W)
	Sizes	13.4	12' x 18" or 12' x 36"	12", 14", 20"
	Housing ²	Diecast	CRS	Diecast
	Lensing	Polycarbonate	Polycarbonate	Polycarbonate
	Uplight	None	None	None
	Life (@ 60K hrs)	L91	L86	L91
	Ambient Range	-20C to 50C	-40C to 45C	-40C to 50C
	Emergency	Remote	Optional	Remote
	Ratings	IP65	Damp, IP5X	IP65, NEMA, 4X, NSF, Wet Location
DLC	Premium	Premium	Premium	

		MarketPro Essentials	MarketPro Essentials	
INTEGRATED CONTROLS	Basic Occupancy		✓	
	Stand Alone Daylight / Occupancy	✓	✓	✓
	WaveLinX		✓	✓

Notes: 1. ★★★ = high applicability, ★★ = medium applicability, ★ = low applicability, blank = non-applicable
2. CRS=Cold-rolled Steel, Extruded= Extruded Aluminum, Diecast=Diecast Aluminum.



WaveLinX LITE



WaveLinX CAT



GREENGATE Switches



GREENGATE Sensors

CONNECTED LIGHTING & CONTROLS

Meet lighting codes, save energy and reduce installation costs for all of your lighting and control needs with WaveLinX, Greengate switches, dimmers and sensors.

WAVELINX LITE



A smarter way to save energy is here!

Save 60% in lighting energy with WaveLinX

WaveLinX is a Cooper Lighting Solutions smart digital lighting system. The WaveLinX solution provides standalone/grouped occupancy sensing, manual/personal dimming control, daylighting and more.

One system for all your spaces

Wireless for Single Spaces

Eliminate low voltage wiring with wireless connected luminaires and control devices for single rooms, areas, or parking spaces.

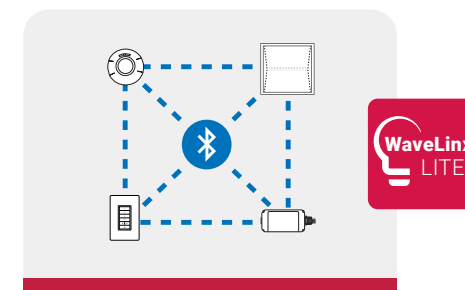

CLICK HERE to learn more about our WaveLinX LITE solution.

See **page 44** for our WaveLinX LITE products.

Wired for Single & Connected Spaces

Simply connect the WaveLinX CAT5 based lighting control devices to control the lights in a single room or area.

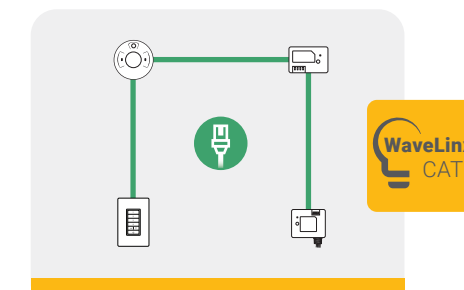

CLICK HERE to learn more about our WaveLinX CAT solution.

See **page 46** for our WaveLinX CAT products.

CGTS Series with WaveLinX LITE FLAT PANEL

- Enable 0-10V luminaires to be controlled by the WaveLinX LITE system
- 120-277VAC with 3 amp relay and 0-10V continuous dimming
- Mounting heights of 8 to 15ft (2.4 to 4.5m)
- Provides PIR and photocell capabilities
- Installs into 1/2-3/4" (12-19mm) ceilings or octagonal junction boxes



Catalog Number	Description	Replaces	CCT	Voltage	Lumens	Watts	UPC	DLC Product ID
14CGTS-L3C3-WLS	1'x4' Recessed Panel with WaveLinX LITE	2-T8	3500K-5000K	120-277V	3,200-5,100	21/31/36	080083306015	S-3EJHF2
22CGTS-L3C3-WLS	2'x2' Recessed Panel with WaveLinX LITE	3-T8 17W, 2-U6T8	3500K-5000K	120-277V	2,500-4,900	21/29/39	080083306022	PL74TQBZR6SL
24CGTS-L3C3-WLS	2'x4' Recessed Panel with WaveLinX LITE	4-T8 32W	3500K-5000K	120-277V	3,700-6,800	27/39/51	080083306039	PL0ULJMKXBCH

WAVELINX LITE



Automate space lighting without requiring on-site programming

CLICK HERE to learn more.

OCS Dual Technology Ceiling Sensor

This digital ceiling sensor provides improved performance vs other dual tech sensors by utilizing both passive infrared (PIR) and acoustic detection reducing the risk of interference or false triggers.

Standalone Functionality

Utilize in standalone spaces that require simple on/off control through excellent out of box performance.

Digital Programming

Customize the sensor performance utilizing the industry leading WaveLinX LITE mobile app to adjust sensor parameters.

Networkable Functionality

Combine with other WaveLinX LITE products to form a mesh network of control devices for use as part of a group of devices.



OPTIONAL Customize settings with the WaveLinX LITE mobile app

Standalone -Line Voltage

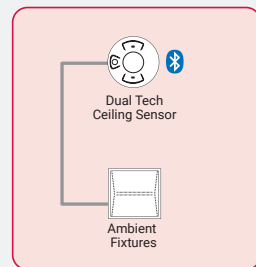

Standalone -Low Voltage

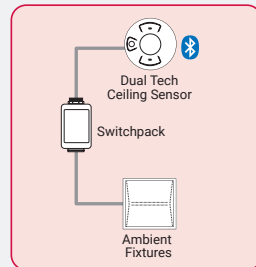

Wireless

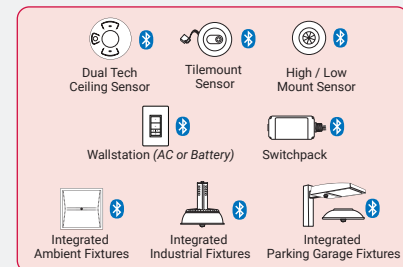

OCS Ceiling Mount Dual Tech SENSOR

- Combines Passive Infrared (PIR) and acoustic technologies, improving accuracy of detection
- Standalone sensors capable of providing on/off functionality with out of the box installation
- Change settings without the need for ladders through the WaveLinX LITE Mobile App
- Pair with WaveLinX LITE devices to create a mesh network for use with other WaveLinX LITE control products



Catalog Number	Description	Finish	Voltage	Detection Type	Coverage	UPC	DLC Product ID
OCS-L-D-06	Dual Tech, Low Voltage Ceiling Sensor 600 sq ft.	White	24VDC	Dual Technology*	600 sq ft.	080083298143	NM8502RF5T1
OCS-L-D-12	Dual Tech, Low Voltage Ceiling Sensor 1200 sq ft.	White	24VDC	Dual Technology*	1200 sq ft.	080083298150	NM8502RF5T1
OCS-L-D-20	Dual Tech, Low Voltage Ceiling Sensor 2000 sq ft.	White	24VDC	Dual Technology*	2000 sq ft.	080083300624	NM8502RF5T1
OCS-L-D-06-MV	Dual Tech, Line Voltage Ceiling Sensor 600 sq ft.	White	120/277VAC	Dual Technology*	600 sq ft.	080083298181	NM8502RF5T1
OCS-L-D-12-MV	Dual Tech, Line Voltage Ceiling Sensor 1200 sq ft.	White	120/277VAC	Dual Technology*	1200 sq ft.	080083298198	NM8502RF5T1
OCS-L-D-20-MV	Dual Tech, Line Voltage Ceiling Sensor 2000 sq ft.	White	120/277VAC	Dual Technology*	2000 sq ft.	080083300648	NM8502RF5T1

*PIR and Acoustics.

WAVELINX LITE

WTK Wireless Tilemount SENSOR KIT

- Enable 0-10V luminaires to be controlled by the WaveLinX LITE system
- 120-277VAC with 3 amp relay and 0-10V continuous dimming
- Mounting heights of 8 to 15ft (2.4 to 4.5m)
- Provides PIR and photocell capabilities
- Installs into 1/2-3/4" (12-19mm) ceilings or octagonal junction boxes



Catalog Number	Description	Finish	Voltage	UPC	DLC Product ID
WTK	WaveLinX LITE Tilemount Sensor Kit	White	120-277V	080083293261	NM8502RF5T1

RSP SWITCHPACK

- 20A rated relay
- 0-10v dimming control
- Plenum-rated design with easy junction box mounting
- Universal voltage input (120, 277 and 347 VAC)
- Suitable for plug load control



Catalog Number	Description	Voltage	UPC	DLC Product ID
RSP-L-010-347	WaveLinX LITE Wireless, Dimming	120/347V	080083288229	NM8502RF5T1

WWL Wallstation WALLSTATION

- Multi-scene selection, and zone programmable
- Suitable for standard single or multi-gang NEMA wall box
- Line voltage (120-277VAC) and battery powered options
- Configurable through software - no physical adjustments

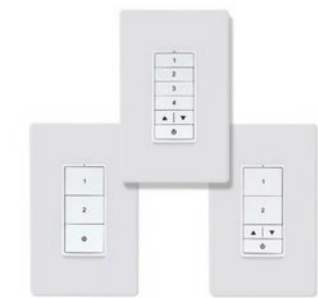

Line Voltage Wallstation

Catalog Number	Description	Finish	Voltage	UPC	DLC Product ID
WWL3-W	Wallstation, 3 Button	White	120-277V	080083283170	NM8502RF5T1
WWL3-RL-W	Wallstation, 3 Button Raise/Lower	White	120-277V	080083282449	NM8502RF5T1
WWL5-RL-W	Wallstation, 5 Button Raise/Lower	White	120-277V	080083283149	NM8502RF5T1

Wireless Battery Powered Wallstation

Catalog Number	Description	Finish	Voltage	UPC	DLC Product ID
WWBL3-W	Wallstation, 3 Button,	White	N/A	080083256600	NM8502RF5T1
WWBL3-RL-W	Wallstation, 3 Button Raise/Lower	White	N/A	080083256198	NM8502RF5T1
WWBL5-RL-W	Wallstation, 5 Button Raise/Lower	White	N/A	080083256181	NM8502RF5T1

WAVELINX CAT

WST WaveLinx CAT WALLSTATION

- On/Off, Raise/Lower and Scene Presets with 1, 3, 5 and 6 button option
- Draws power from CAT communications bus to simplify wiring
- Clean and elegant with a custom button engraving option to enhance occupant experience
- Button actions are configurable through the WaveLinx app
- Remotely upgradeable firmware



Catalog Number	Description	Finish	UPC	DLC Product ID
WST-C-1	WaveLinx CAT Wallstation, 1 Button	White	080083272433	N-X04521
WST-C-3	WaveLinx CAT Wallstation, 3 Button	White	080083272457	N-X04521
WST-C-3D	WaveLinx CAT Wallstation, 3 Button Dimming	White	080083272471	N-X04521
WST-C-5D	WaveLinx CAT Wallstation, 5 Button Dimming	White	080083272495	N-X04521
WST-C-1-Z1	WaveLinx CAT Wallstation, 1 Button, Zone 1	White	080083470679	N-X04521
WST-C-1-Z2	WaveLinx CAT Wallstation, 1 Button, Zone 2	White	080083470693	N-X04521
WST-C-1-Z3	WaveLinx CAT Wallstation, 1 Button, Zone 3	White	080083470716	N-X04521
WST-C-1-Z4	WaveLinx CAT Wallstation, 1 Button, Zone 4	White	080083470730	N-X04521
WST-C-1D-Z1	WaveLinx CAT Wallstation, 1 Button Dimming, Zone 1	White	080083467693	N-X04521
WST-C-1D-Z2	WaveLinx CAT Wallstation, 1 Button Dimming, Zone 2	White	080083470617	N-X04521
WST-C-1D-Z3	WaveLinx CAT Wallstation, 1 Button Dimming, Zone 3	White	080083470631	N-X04521
WST-C-1D-Z4	WaveLinx CAT Wallstation, 1 Button Dimming, Zone 4	White	080083470655	N-X04521
WST-C-3-Z1Z2	WaveLinx CAT Wallstation 3 Button, Zone 1 & 2	White	080083470792	N-X04521
WST-C-3-Z3Z4	WaveLinx CAT Wallstation 3 Button, Zone 3 & 4	White	080083470815	N-X04521
WST-C-3D-Z1Z2	WaveLinx CAT Wallstation 3 Button Dimming, Zone 1 & 2	White	080083470754	N-X04521
WST-C-3D-Z3Z4	WaveLinx CAT Wallstation 3 Button Dimming, Zone 3 & 4	White	080083470778	N-X04521
WST-C-5D-Z	WaveLinx CAT Wallstation, 5 Button Dimming, Zone 1, 2, 3 & 4	White	080083470839	N-X04521

Occupancy Ceiling Sensor WaveLinx CAT INTERFACE MODULE

- Passive Infrared sending technology to detect motion up to 12 ft mounting height
- 600 and 1200 sqft coverage with high sensitivity core
- Built-in photocell to dim or turn off the lights based on daylight coming into the space
- LED Status Indicator for simple troubleshooting
- Draws power from CAT communications bus to simplify wiring



Catalog Number	Description	Finish	Detection Type	Coverage	UPC	DLC Product ID
OCS-C-D06	WaveLinx CAT Dual Tech Ceiling Sensor, 600 sqft.	White	Dual Tech	600 sqft	080083303007	N-X04521
OCS-C-D12	WaveLinx CAT Dual Tech Ceiling Sensor, 1200 sqft	White	Dual Tech	1200 sqft	080083303021	N-X04521
OCS-C-D20	WaveLinx CAT Dual Tech Ceiling Sensor, 2000 sqft	White	Dual Tech	2000 sqft	080083303045	N-X04521
OCS-C-P06	WaveLinx CAT PIR Ceiling Sensor, 600 sqft	White	PIR	600 sqft	080083272419	N-X04521
OCS-C-P12	WaveLinx CAT PIR Ceiling Sensor, 1200 sqft	White	PIR	1200 sqft	080083272297	N-X04521

Accessories

Catalog Number	Description	UPC
ACC-C-TP-6PK	ACC-C Canbus Termination Plug (6-Pack)	080083285846

WAVELINX CAT

BPI Bluetooth Programming WaveLinx CAT INTERFACE MODULE

- Bluetooth radio used to pair to a mobile device with WaveLinx CAT app
- Two RJ45 ports used to connect to CAT communication bus and other CAT devices
- Draws power from CAT communications bus to simplify wiring
- Remotely upgradeable firmware and ncrpyted authentication to a WaveLinx Mobile App for secure programming



Catalog Number	Description	UPC	DLC Product ID
BPI-C-L	L BPI-C Bluetooth Program Interface	080083272693	N-X04521

Accessories

Catalog Number	Description	UPC
ACC-C-TP-6PK	ACC-C Canbus Termination Plug (6-Pack)	080083285846

RSP Dimming WaveLinx CAT SWITCHPACK

- Control (on/off/dim) commercial fixtures using 20A Relay and an 0-10V dimming output
- Plenum-rated design with easy junction box mounting
- 24VDC output power to power the CAT bus and CAT devices
- Two RJ45 connectors to daisy chain with other CAT devices using standard CAT5 cabling



Catalog Number	Description	Voltage	UPC	DLC Product ID
RSP-C-010-Z1	WaveLinx CAT RSP-C Relay Switchpack - Zone 1	120-277V	080083272518	N-X04521
RSP-C-010-Z2	WaveLinx CAT RSP-C Relay Switchpack - Zone 2	120-277V	080083272532	N-X04521
RSP-C-010-Z3	WaveLinx CAT RSP-C Relay Switchpack - Zone 3	120-277V	080083272556	N-X04521
RSP-C-010-Z4	WaveLinx CAT RSP-C Relay Switchpack - Zone 4	120-277V	080083475704	N-X04521
RSP-C-ZR	WaveLinx CAT RSP-C Relay Switchpack - Zone Receptacle	120-277V	080083272518	N-X04521

Accessories

Catalog Number	Description	UPC
ACC-C-TP-6PK	ACC-C Canbus Termination Plug (6-Pack)	080083285846

ESP Emergency Dimming WaveLinx CAT SWITCHPACK

- UL924 control device for emergency fixtures
- Control (on/off/dim) commercial fixtures using 20A Relay and an 0-10V dimming output
- Plenum-rated design with easy junction box mounting
- 24VDC output power to power the CAT bus and CAT devices
- Two RJ45 connectors to daisy chain with other CAT devices using standard CAT5 cabling



Catalog Number	Description	Voltage	UPC	DLC Product ID
ESP-C-010-Z1	ESP-C Emergency Relay Switchpack - Zone 1	120-277V	080083272570	N-X04521

Accessories

Catalog Number	Description	UPC
ACC-C-TP-6PK	ACC-C Canbus Termination Plug (6-Pack)	080083285846

GREENGATE SWITCHES | SENSORS

WBSD 0-10V Decorator Dimmer

WALL SWITCH

- Provides a full-range of linear-slide dimming control of 0-10V compatible light sources
- Allows user to return to previous light level when turning lights ON
- Can be used in single-pole (1 location) and 3-way (multi-location) applications
- Neutral wire is not required for installation of device
- Ideal for light commercial applications; Compatible with decorator style devices and wallplates



Catalog Number	Description	Finish	Voltage	UPC
WBSD-010DEC-C1	0-10V Decorator Dimmer	White, Ivory, Almond	120V/277V	080083735266
WBSD-010DEC-C2	0-10V Decorator Dimmer	White, Ivory, Light Almond	120V/277V	080083735273

WBSD 0-10V Preset Slide Dimmer

WALL SWITCH

- Full-travel slide control; LED ready
- Class 1 or Class 2 wiring capabilities
- Can be used in single-pole (1 location) and 3-way (multi-location) applications
- Works with the SP20-RD4 or directly controls the load
- White face assembled on device, Ivory and Light Almond color change kits included



Catalog Number	Description	Finish	Voltage	UPC
WBSD-010M-C1	0-10V Preset Slide Dimmer	White	120/277 VAC	080083834983

OSW 0-10V Dimmer with Dual Tech Sensor

SENSOR

- 3-in-1 solution that combines functionality of a switchpack, a sensor and a 0-10V dimmer
- Saves labor costs, reduces installation time and meets energy codes and standards
- Ultrasonic occupancy (US) and passive infrared (PIR) sensing; Daylight harvesting
- Can be used in single-pole (1 location) as well as 3-way (multi-location) applications
- Compatible with Cooper Lighting Solutions' decorator style devices and wallplates



Catalog Number	Description	Finish	Voltage	Watts	Detection Type	Coverage	UPC
OSW-D-010-W	0-10V Dimmer, OCC Sensor	White	120/277V	960W/2,200W	PIR and Ultrasonic	1,000 sq ft.	080083816071

GREENGATE | WAVELINX SENSORS

ONW Switch with Sensor

SENSOR

- Passive Infrared (PIR) single level occupancy sensing switch for motion sensing control
- Also a conventional wall switch; Designed for energy savings and convenience
- Detects motion from a heat-emitting source (such as a person entering a room) within its field-of-view and automatically switches lights ON
- Neutral and non-neutral wiring options for installation; Ideal for retrofit applications



Catalog Number	Description	Finish	Voltage	Watts	Detection Type	Coverage	UPC
ONW-P-1001-MV-W	PIR Wall Sensor	White	120/277V	1,200W/2,200W	PIR	1,000 sq ft.	080083523863
ONW-D-1001-MV-W	Dual Tech Wall Sensor	White	120/277V	1,200W/2,200W	PIR and Ultrasonic	1,000 sq ft.	080083524709
ONW-D-1001-MV-N-W	Dual Tech Wall Sensor, Neutral Required	White	120/277V	1,200W/2,200W	PIR and Ultrasonic	1,000 sq ft.	080083524594

OEF High Bay Fixture Mount Sensor

SENSOR

- Fixture-mount high bay/low bay occupancy sensor with integrated photocell
- Provides 0-10V control and 1-100% continuous dimming
- 2 interchangeable 360° high bay and low bay lenses; specifically designed for LED fixture control
- Easy to program; Quicksnap feature for easy installation
- Suitable for use in standard and cold storage applications



Catalog Number	Description	Finish	Voltage	Watts	Detection Type	Coverage	UPC
OEF-P-010V-MV	Fixture Mount Sensor	White	120/277V	1200	PIR	1,500 sq ft.	080083758104

OCS Ceiling Mount Dual Tech WaveLinX

SENSOR

- Standalone sensors capable of providing on/off functionality with out-of-the-box installation
- Line and low voltage options with in 600 sq. ft., 1200 sq. ft. and 2000 sq. ft. coverage options
- Provides improved performance vs other dual tech sensors by utilizing both passive infrared (PIR) and acoustic detection, reducing risk of interference or false triggers.
- For additional functionalities, including in app easy programming and networking features, see the WaveLinX LITE section.



Catalog Number	Description	Finish	Voltage	Detection Type	Coverage	UPC	DLC Product ID
OCS-L-D-06	Dual Tech, Low Voltage Ceiling Sensor 600 sq ft.	White	24VDC	Dual Technology*	600 sq ft.	080083298143	NM8502RF5T1
OCS-L-D-12	Dual Tech, Low Voltage Ceiling Sensor 1200 sq ft.	White	24VDC	Dual Technology*	1200 sq ft.	080083298150	NM8502RF5T1
OCS-L-D-20	Dual Tech, Low Voltage Ceiling Sensor 2000 sq ft.	White	24VDC	Dual Technology*	2000 sq ft.	080083300624	NM8502RF5T1
OCS-L-D-06-MV	Dual Tech, Line Voltage Ceiling Sensor 600 sq ft.	White	120/277VAC	Dual Technology*	600 sq ft.	080083298181	NM8502RF5T1
OCS-L-D-12-MV	Dual Tech, Line Voltage Ceiling Sensor 1200 sq ft.	White	120/277VAC	Dual Technology*	1200 sq ft.	080083298198	NM8502RF5T1
OCS-L-D-20-MV	Dual Tech, Line Voltage Ceiling Sensor 2000 sq ft.	White	120/277VAC	Dual Technology*	2000 sq ft.	080083300648	NM8502RF5T1

*PIR and Acoustics.



Sure-Lites



All-Pro



AtLite

SURE-LITES ALL-PRO | ATLITE EXIT & EMERGENCY

Sure-Lites, All-Pro and AtLite offer reliable and code compliant solutions for all your exit and emergency needs.

SURE-LITES EMERGENCY LIGHTING

Innovative Design. Dependable. ▶▶▶

Sure-Lites offers emergency lighting fixtures, exit signs and battery packs, including Chicago and New York code compliant solutions ideal for commercial and industrial applications.

SELHP EMERGENCY LIGHTING

- Provides emergency lighting for a minimum of 90 minutes
- Up to 100 feet of emergency egress coverage
- Long life LED's with LiFePO4 battery, 3 watts remote capacity
- Labor savings self-diagnostics option
- Wall and ceiling mount



Catalog Number	Description	Finish	Replaces	Coverage	Voltage	Watts	UPC
SELHP100R3	2 Head, LiFePO4	White	2 - 24W Hal. Heads	100 ft.	120~277V	2.6W	080083276721
SELHP100R3SD	2 Head, LiFePO4, Self Diagnostic	White	2 - 24W Hal. Heads	100 ft.	120~277V	4.6W	080083276707

SEL Series EMERGENCY LIGHTING

- Designed to reduce egress system cost and maintenance and improve reliability
- Proprietary adjustable AccuLED Optics™ and injection-molded, high-impact thermoplastic housing
- Long life LED's, no maintenance nickel cadmium battery
- EZ hang feature reduces installation time and cost
- Labor savings self-diagnostics available in SD models

Updated Optics
with higher egress
coverage.



MarketPro Essentials

Catalog Number	Description	Finish	Replaces	Fixture Spacing	Voltage	Watts	UPC
ES SEL17	2 Head, NiCad	White	2-5.4W INC. Heads	17 ft.	120-277V	0.78W	080083722143

Catalog Number	Description	Finish	Replaces	Fixture Spacing	Voltage	Watts	UPC
SEL25	2 Head, NiCad	White	2-9W INC. Heads	35 ft.	120-277V	0.6W/0.64W	080083736669
SEL25SD	2 Head, NiCad, Self-Diagnostics	White	2-9W INC. Heads	25 ft.	120-277V	0.67	080083723027
SEL50	2 Head, NiCad	White	2-12W INC. Heads	59 ft.	120-277V	1W/1.02W	080083733347
SEL50SD	2 Head, NiCad, Self-Diagnostics	White	2-12W INC. Heads	50 ft.	120-277V	1.19	080083733361
SEL60R4	2 Head, NiCad Emergency Light	White	N/A	60 ft.	120/240/277V AC	1.7	080083733422

SELW Outdoor Series EMERGENCY LIGHTING

- Code compliant, wet location for outdoor use; Standard 0°C to 40°C temperature rating
- Designed to reduce egress system cost and maintenance and improve reliability
- Proprietary adjustable AccuLED Optics™; 25 feet of emergency egress coverage
- Injection-molded, high-impact thermoplastic
- Long life LED's; No maintenance nickel cadmium battery



Catalog Number	Description	Finish	Replaces	Coverage	Voltage	Watts	UPC
SELW25BZ	2 Rotatable Heads, NiCad	Bronze	2-9W INC Heads	25 ft.	120-277V	1.4	080083764037

SURE-LITES EMERGENCY LIGHTING

LPX Series EXIT SIGNAGE

- Injection-molded polycarbonate housing
- Field-Selectable for single or double face; red or green illumination
- Snap-out or snap-in chevron directional indicators
- EZ key external battery disconnect



Catalog Number	Description	Finish	Voltage	Watts	UPC
LPX7	Self Powered, Univ. Red and Green	White	120/277V	0.98W/1.03W	080083532773

LPXC Series EMERGENCY LIGHTING

- Injection-molded polycarbonate housing
- Field-Selectable for single or double face; red or green illumination
- Snap-out or snap-in chevron directional indicators
- EZ key external battery disconnect



Catalog Number	Description	Finish	Replaces	Coverage	Voltage	Watts	UPC
LPXC25	2 Heads, Univ. Red and Green, Remote Cap.	White	2-9W INC Heads	25 ft.	120/277V	3.2 W at 277 V	080083770922

CHX Series EXIT SIGNAGE

- Chicago code compliant exits are ideal for general purpose applications
- Extensive range of field-installed accessories and choice of faces
- Lens installs from side of fixture for convenient maintenance
- Steel canopy allows ceiling or end mounting
- Rear universal pattern knockouts for direct mounting to jbox



Catalog Number	Description	Finish	Replaces	Coverage	Voltage	Watts	UPC
CHX61	AC Powered, Steel	White	2-12 W INC Heads	N/A	120/277V	3	080083574629
CHX70	Self Powered, Steel	White	2-12 W INC Heads	N/A	120/277V	3	080083576753
CHX71	Self Powered, Steel	White	2-12 W INC Heads	N/A	120/277V	3	080083567614
CHXC71	Self Powered Combo Unit, Steel	White	2-12 W INC Heads	60 ft.	120/277V	3.6	080083771271

SURE-LITES EMERGENCY LIGHTING

SCX Complete Edge Lit Exit EXIT SIGNAGE

- Universal mount: surface ceiling, wall, end mount, recessed ceiling and wall mount
- Pivot housing for sloped ceiling or back wall mount
- Single-sided clear and double-sided mirror lens panels included
- Bright red or green LED sources
- Battery backup models provide 90 minutes of emergency run time



Catalog Number	Description	Finish	Replaces	Coverage	Voltage	Watts	UPC
SCX70R	Self Powered, Red Aluminum	Satin Aluminum	N/A	N/A	120/277V	3.14	080083277704
SCX70G	Self Powered, Green Aluminum	Satin Aluminum	N/A	N/A	120/277V	2.94	080083277728

XR Series EMERGENCY LIGHTING

- Emergency light with minimum of 90 minutes runtime; Chicago and New York City compliant
- 20-gauge sheet metal housing; heads are fully adjustable and 300 lumens each
- Designed to reduce egress system cost and maintenance and improve reliability
- Proprietary adjustable AccuLED Optics™; No maintenance nickel cadmium battery
- External battery disconnect and EZ Hang feature reduces installation time and cost



Catalog Number	Description	Finish	Replaces	Coverage	Voltage	Watts	UPC
XR6C-LED	Steel, NiCad	White	2-12W INC Heads	60 ft.	120-277V	1.7	080083753215

EBP Series EMERGENCY BATTERY PACKS

- LED Battery Pack automatically switches to emergency mode when AC power fails
- Maintains illumination of a fixture for a minimum of 90 minutes
- UL 924 classified for field retrofit installation
- Labor savings self-diagnostics available in SD models



MarketPro Essentials

Catalog Number	Description	Voltage	Watts	UPC
ES EBPLEDL7W	LED Emergency Battery Pack	120/277V	7	080083289844
ES EBPLEDL14W	LED Emergency Battery Pack	120/277V	14	080083289868

ALL-PRO EMERGENCY LIGHTING

Compact Design. Value Focused. ▶▶▶

All-Pro offers a broad line of compact and affordable LED emergency lighting fixtures designed for commercial and industrial applications.

APEL Series EMERGENCY LIGHTING

- Emergency light with a minimum of 90 minutes of run time
- No maintenance nickel cadmium battery
- Fully adjustable LED heads maximizes design flexibility
- Components are injection-molded, high impact thermoplastic
- Universal jbox mounting pattern and snap-fit housing



MarketPro Essentials

Catalog Number	Description	Finish	Replaces	Coverage	Voltage	Watts	UPC
ES APEL	2 Head, NiCad	White	2-5.4W INC Heads	17 ft.	120/277V	0.47W at 277V	080083566501

*Egress coverage with APELH2 + remote head units.

AP2SQLED30 Series EMERGENCY LIGHTING

- Next generation square head emergency light
- Provides up to 30 feet of egress coverage for 90 minutes
- Each adjustable square head outputs 80 lumens
- No maintenance nickel cadmium battery
- Universal jbox mounting pattern and snap-fit polycarbonate housing



Catalog Number	Description	Finish	Replaces	Coverage	Voltage	Watts	UPC
AP2SQLED30	2 Head, NiCad 30° Egress	White	2-9W INC Heads	30 ft.	120/277V	2 at 277V	080083264285

APWR Series EMERGENCY LIGHTING

- Emergency lighting remote heads unit; Allows for 17 feet of emergency egress coverage
- Adjustable heads adjust 80° from vertical with 358° rotation
- Wet location listed and can be used indoors or outdoors
- Injection-molded thermoplastic material
- Universal mounting plate; Flame-resistant and impact-resistant



Catalog Number	Description	Finish	Replaces	Coverage	Voltage	Watts	UPC
APWR2	Remote Emergency Lamps, 2 Heads	White	2-5.4W INC. Heads	17 ft.	3.6V	1W	080083608584

ALL-PRO EMERGENCY LIGHTING

APX Series EXIT SIGNAGE

- Economical LED exit sign for general purpose applications
- Durable, injection-molded, thermoplastic material resists discoloration
- Field-Selectable red or green LEDs and faces
- Universal configurations (single and double-face); Universal mounting (ceiling, wall and end)



MarketPro Essentials

Catalog Number	Description	Finish	Voltage	Watts	UPC
ES APX7RG	Self Powered, Unv. Red/Green	White	120/277V	1.05W at 277V	080083281107

APC Combo Series EMERGENCY LIGHTING

- Economical LED combo unit; Exit and LED emergency lighting heads
- Durable, injection-molded, thermoplastic material resists discoloration
- Field-Selectable red or green LEDs and faces
- Universal configurations (single and double-face); Universal mounting (ceiling, wall and end)
- Low-voltage disconnect, Line-Latched; Brownout circuit



MarketPro Essentials

Catalog Number	Description	Finish	Replaces	Coverage	Voltage	Watts	UPC
ES APC7RG	2 Heads, Unv. Red/Green	White	2-5.4W Inc. Heads	17 ft.	120/277V	4.04W at 277V	080083280827

Catalog Number	Description	Finish	Replaces	Coverage	Voltage	Watts	UPC
APCH7RG	2 Heads, Unv. Red/Green, Remote Cap.	White	4-5.4W Inc. Heads	34 ft.*	120/277V	3.79W at 277V	080083280865
APC7RGSQ30	2 Sq. Heads, Unv. Red/Green	White	2 - 10W Inc. Heads	30 ft	120/277V	1.2W at 277V	080083296859
APCH7RGSQ30	2 Sq. Heads, Unv. Red/Green, Remote Cap.	White	2 - 10W Inc. Heads	47 ft*	120/277V	1.2W at 277V	080083296873

*Egress coverage with APCH + Remote head units.

ATLITE EXIT SIGNAGE

Durable Design. Built-to-Last. ▶▶▶

AtLite offers durable and dependable emergency lighting and exits for commercial and industrial applications that are also approved for the New York City market.

RCS Combo Series EXIT SIGNAGE

- New York City compliant LED combo exit sign
- Heavy-duty, 20-gauge steel housing and face plate provides durability
- Energy-efficient, long-life LED's; illuminated by field-replaceable LED strip
- Single or double face with maximum of three heads for ultimate flexibility



Catalog Number	Description	Finish	Replaces	Voltage	Watts	UPC
RCS182LED	Steel Combo, 1 Face, 2 Heads	White	2 12W INC. Heads	120/277V	N/A	080083574322
RCS183LED	Steel Combo, 1 Face, 3 Heads	White	3 12W INC. Heads	120/277V	N/A	080083574308
RCS282LED	Steel Combo, Double Face, 2 Heads	White	2 12W INC. Heads	120/277V	N/A	080083574315
RCS283LED	Steel Combo, Double Face, 3 Heads	White	3 12W INC. Heads	120/277V	N/A	080083574292

Rival RXS Series EXIT SIGNAGE

- New York City compliant steel LED exit sign
- Heavy-duty, 20-gauge steel housing with canopy
- Energy-efficient, long-life LED's; illuminated by field-replaceable LED strip
- Universal configurations (single- and double-face); Universal mounting (ceiling, wall and end)



Catalog Number	Description	Finish	Voltage	Watts	UPC
RXSN8RU	Steel Exit, Self Powered, Univ. Face	White	120/277V	5	080083634576

REL Series EMERGENCY LIGHTING

- New York City compliant steel LED emergency light
- Heavy-duty, 20-gauge steel housing and face plate for maximum durability
- Long-lasting, high-efficiency LED heads; maintenance-free nickel cadmium battery
- Brownout protection; low-voltage disconnect



Catalog Number	Description	Finish	Replaces	Voltage	Watts	UPC
10REL36-LED42	Steel Emergency Light, 2 Heads, 2 Remotes	White	2 9W INC. Heads	120/277V	5	080083574353
10REL72-LED83	Steel Emergency Light, 3 Heads, 5 Remotes	White	2 9W INC. Heads	120/277V	5	080083574339

ATLITE EXIT SIGNAGE

ATLEMINI Series EMERGENCY LIGHTING

- New York City compliant LED emergency light with 90 minutes of run time
- Jbox and conduit knockouts for easy installation; wall or ceiling mount applications
- Long-lasting, energy-efficient LED heads; maintenance-free nickel cadmium battery
- Available with two or three 80 lumen rotatable heads



Catalog Number	Description	Finish	Replaces	Coverage	Voltage	Watts	UPC
ATLEMINI-2H	Steel Emergency Light, 2 Heads	White	5.4 W INC	18 ft.	120-277V	0.78 W	080083836079

AUX Edge-Lit Exit Series EXIT SIGNAGE

- Edge-Lit Exit allows seamless presence in architecturally significant surroundings
- Labor savings self-diagnostics, New York City compliant
- Universal mounting; Universal Lens (clear, mirror, white and single- and double-sided)
- Ordering and installation simplified as all housing and lens options are included



Catalog Number	Description	Finish	Voltage	Watts	UPC
AUXSSD	Unv. Self Powered, Self-Diag., 8" Letters	Silver	120/277V	1.1 at 277 V	080083703296
AUXSSD6	Unv. Edge Lit, Self Powered, 6" Letters	Silver	120/277V	0.9/1.1W	080083718115
AUXSSD-SP PACK	Unv. Self Powered, Self-Diag., Single Pack	Silver	120/277V	1.1 at 277 V	080083848669

ACX Complete Edge Lit Exit EXIT SIGNAGE

- Surface ceiling, wall, end mount, recessed ceiling and wall mount
- Pivot housing for sloped ceiling or back wall mount
- NYC Compliant 8" letter single-sided clear and double-sided mirror lens panels included
- Battery backup models provide 90 minutes of emergency run time
- NFPA approved field installable directional chevrons included



Catalog Number	Description	Finish	Replaces	Coverage	Voltage	Watts	UPC
ACXN0R	Self Powered, Aluminum	Satin Aluminum	N/A	N/A	120/277 V	3.14	080083277742



Wall Mounts



Floodlights



Ceiling Mounts



Area/Site

LUMARK AP

LUMARK

OUTDOOR LUMINAIRES

Lumark brands offer a wide selection of high-quality product solutions that provide market-leading ease of installation, superior area safety, and maximum energy savings in commercial and industrial spaces.

LUMARK AP WALL MOUNTS

AWP Architectural Wall Pack WALL MOUNT

- Customizable 0–45° rotatable optics for targeted lighting
- Finned or smooth front options available to match any building style
- Flexibility with field-selectable 3-color CCT (3000K/4000K/5000K)
- Wide coverage with field-selectable 2,600–20,500 lumens
- Durable die-cast housing with hinged, removable door for quick installation

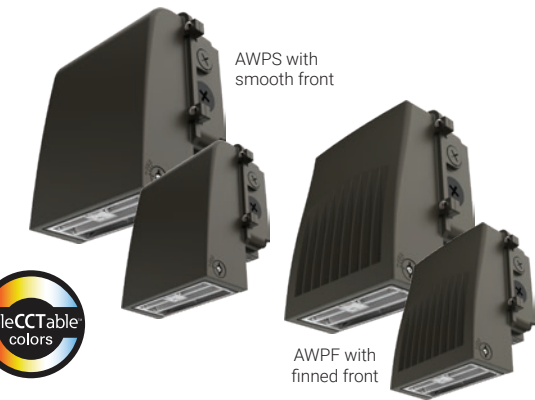

MarketPro Essentials

Catalog Number	Description	Finish	Replaces	Selectable CCT	Voltage	Selectable Lumens	Watts	UPC	DLC Product ID
ES AWPS28S-BZ	Architectural Wall Pack Small Smooth	Bronze	70W MHL	3000K-5000K	120-347V	2,600-3,900	20-28W	080083448388	S-F8CW7W
ES AWPS75S	Architectural Wall Pack Medium Smooth	Bronze	125W MHL	3000K-5000K	120-347V	7,600-10,800	55-75W	080083448401	S-49BL0W
ES AWPS150S	Architectural Wall Pack Large Smooth	Bronze	250W MHL	3000K-5000K	120-347V	13,300-20,500	100-50W	080083448425	S-X57MKV
ES AWP28S-BZ	Architectural Wall Pack Small Fins	Bronze	70W MHL	3000K-5000K	120-347V	2,600-3,900	20-28W	080083448449	S-65SK3W
ES AWP75S-BZ	Architectural Wall Pack Medium Fins	Bronze	125W MHL	3000K-5000K	120-347V	7,600-10,800	55-75W	080083448463	S-M57PTM
ES AWP150S	Architectural Wall Pack Large Fins	Bronze	250W MHL	3000K-5000K	120-347V	13,300-20,500	100-50W	080083448487	S-WH92RW

Note: DLC Premium items are noted in bold.

WP Wall Pack WALL MOUNT

- Three housing sizes for versatile lighting applications
- Flexibility with field-selectable 5-color CCT (3000K/3500K/4000K/5000K/6500K)
- Wide coverage with field-selectable 4,300–21,000 lumens
- Borosilicate glass and die-cast housing to withstand heat, weather, and impacts
- Quick installation and access with hinged, removable door design



MarketPro Essentials

Catalog Number	Description	Finish	Replaces	Selectable CCT	Voltage	Selectable Lumens	Watts	UPC	DLC Product ID
ES WPSLED15S	Small LED Wall Pack	Bronze	150W HID	3000K-6500K	120-347V	4,300-8,100	30-60W	080083304561	S-G2CQRH
ES WPMLED26S	Medium LED Wall Pack	Bronze	350W HID	3000K-6500K	120-347V	10,000-14,900	70-100W	080083304585	S-G2CQRH
ES WPLLED38S	Large LED Wall Pack	Bronze	500W HID	3000K-6500K	120-347V	17,300-21,000	120-150W	080083304707	S-34RRLO

Note: DLC Premium items are noted in bold.

CYL Wall Cylinder WALL MOUNT

- Three lighting styles in one - configure as a downlight, uplight, or both
- Flexibility with field-selectable 3-color CCT (3000K/4000K/5000K)
- Wide coverage with field-selectable 1,600–3,600 lumens
- Rugged die-cast housing with sealed lens for weather-resistant performance
- Ideal for walkways, parking lots, and building areas



Also available in Bronze

MarketPro Essentials

Catalog Number	Description	Finish	Replaces	Selectable CCT	Voltage	Selectable Lumens	Watts	UPC	DLC Product ID
ES CYL-2D-30W-PC-BK	6" Cylinder	Black	70W HID	3000K-5000K	120-347V	1,600-3,600	30W	080083445998	S-MQXYX1
ES CYL-2D-30W-PC-BZ	6" Cylinder	Bronze	70W HID	3000K-5000K	120-347V	1,600-3,600	30W	080083446001	S-MQXYX1

Note: DLC Premium items are noted in bold.

LUMARK AP WALL MOUNTS | FLOODLIGHTS | CEILING MOUNTS

WPSQ Square Wall Pack WALL MOUNT

- Built-in photocontrol for automated security lighting and energy saving
- Flexibility with field-selectable 3-color CCT (3000K/4000K/5000K)
- Wide coverage with field-selectable 10,200-13,700 lumens
- Borosilicate glass and die-cast housing to withstand heat, weather, and impacts
- Ideal for building entrances, vehicle ramps, stairways, loading docks and more



MarketPro Essentials

Catalog Number	Description	Replaces	Selectable CCT	Voltage	Selectable Lumens	Watts	UPC	DLC Product ID
ES WPSQ25S-347-PC	Square Wall Mount	250W HID	3000-5000K	120-347V	10,200-13,700	70W-100W	080083307203	S-KXHMTG

LSF Floodlight FLOODLIGHT

- Three housing sizes for versatile lighting applications
- Flexibility with field-selectable 3-color CCT (3000K/4000K/5000K)
- Wide coverage with field-selectable 1,700-20,000 lumens
- Knuckle, slipfitter, trunnion, and yoke mounting options available
- Ideal for walls, polls, brackets, or ground installation



MarketPro Essentials

Catalog Number	Description	Finish	Replaces	Selectable CCT	Voltage	Selectable Lumens	Watts	UPC	DLC Product ID
ES LSF25-KNYK-PC	Yoke Mount, Photocontrol	Bronze	155W HID	3000K-5000K	120-347V	1,700-4,000	11-25W	080083305230	S-W43YTM
ES LSF120-SFTR-PC	Trunnion Mount, Photocontrol	Bronze	450W HID	3000K-5000K	120-347V	9,000-20,000	50-120W	080083305278	S-M4YHAF

Note: DLC Premium items are noted in bold.

CLCS Canopy CEILING MOUNT

- Two housing sizes for versatile lighting applications
- Flexibility with field-selectable 3-color CCT (3000K/4000K/5000K)
- Wide coverage with field-selectable 3,400-17,600 lumens
- Dusk to dawn capability with ON/OFF photocontrol
- Quick installation in new or existing canopies for drive-thrus, gas stations, and walkways



MarketPro Essentials

Catalog Number	Description	Finish	Replaces	Selectable CCT	Voltage	Selectable Lumens	Watts	UPC	DLC Product ID
ES CLCS15S-PC	Small LED Canopy	Bronze	150-300W HID	3000K-5000K	120-347V	3,400-8,200	24-60W	080083304905	S-GFY8QK
ES CLCS30S-PC	Large LED Canopy	Bronze	150-300W HID	3000K-5000K	120-347V	7,300-17,600	50-120W	080083304929	S-L00Y67

LUMARK AP CEILING MOUNTS | AREA / SITE

RPGC Round Canopy CEILING MOUNT

- Round drop lens provides uplight to eliminate dark ceilings
- Flexibility with field-selectable 2-color CCT (4000K/5000K)
- Wide coverage with field-selectable 3,700-7,800 lumens
- Low profile, die cast aluminum housing
- Easy installation with quick-mount bracket for hands-free wiring



Catalog Number	Description	Finish	Replaces	Selectable CCT	Voltage	Selectable Lumens	Watts	UPC	DLC Product ID
RPGC25S	Round Parking Garage, UNV	White	150-250W HID	4000K-5000K	120-347V	3,700-7,800	28-60W	080083911769	P8ZU6PEI
RPGC25-MS/DIM-L08	Round Parking Garage, UNV, 8' Sensor Ht	White	150-250W HID	4000K-5000K	120-347V	3,700-7,800	28-60W	080083911806	P8ZU6PEI
RPGC25-MS/DIM-L20	Round Parking Garage, UNV, 20' Sensor Ht	White	150-250W HID	4000K-5000K	120-347V	3,700-7,800	28-60W	080083911820	P8ZU6PEI

Note: DLC Premium items are noted in bold.

BOL Bollard AREA/SITE

- Four head options for versatile lighting design flexibility
- Flexibility with field-selectable 3-color CCT (3000K/4000K/5000K)
- Wide coverage with field-selectable 1,300-3,800 lumens
- Designed with future battery pack capability and IP65 durability
- Ideal for parking lots, pedestrian spaces, walkways and building areas



Catalog Number	Description	Finish	Selectable CCT	Voltage	Selectable Lumens	Watts	UPC	DLC Product ID
BOLD42-25S*	Dome-shaped Bollard	Bronze	3000K-5000K	120-277V	2,300-3,800	15-26W	080083445189	S-2R1M3M
BOLY42-25S*	Y-Shaped Bollard	Bronze	3000K-5000K	120-277V	1,800-3,300	15-26W	080083445196	S-XN55BZ
BOLF42-25S	Flat Top Bollard	Bronze	3000K-5000K	120-277V	1,300-2,400	15-26W	080083445189	N/A
BOLR42-25S	Round Top Bollard	Bronze	3000K-5000K	120-277V	1,300-2,400	15-26W	080083445813	N/A

* DesignLights Consortium® Qualified. Refer to www.designlights.org Qualified Products List under Family Models for details.

Accessories

Catalog Number	Description	UPC
BOLHKIT	Spare Hardware Kit: Anchor Bolt Carrier (x1), Nut (x12), Spring Washer (x3), Flat Washer (x6), Anchor Bolts (x3), Hex Wrench (x1)	080083445820

LUMARK AP AREA / SITE

XAS All-Selectable AREA/SITE

- 2 housing sizes (180W & 300W) with 4 selectable lumen levels
- 3 Color Selectable CCT – 3000K/4000K/5000
- 3 Field Selectable distribution – T3, T4, T5; no lens change is required
- Pole mount and adjustable slipfitter mounting arm included with fixture
- Twist-lock NEMA photocontrol for dusk-to-dawn operation included



Catalog Number	Description	Finish	Replaces	CCT	Voltage	Lumens	Watts	UPC	DLC Product ID
XAS180-SFPM-BZ	180W, Slipfitter and Pole Mount	Bronze	N/A	3000K-5000K	120-347V	11,000-28,000	72-180W	080083458226	Pending
XAS180-SFPM-BK	180W, Slipfitter and Pole Mount	Black	N/A	3000K-5000K	120-347V	11,000-28,000	72-180W	080083458745	Pending
XAS300-SFPM-BZ	300W, Slipfitter and Pole Mount	Bronze	N/A	3000K-5000K	120-347V	20,000-46,000	120-300W	080083458240	Pending
XAS300-SFPM-BK	300W, Slipfitter and Pole Mount	Black	N/A	3000K-5000K	120-347V	20,000-46,000	120-300W	080083458769	Pending

XAS Accessories

Catalog Number	Description	Finish	UPC
ADJPM-XAS-BZ	Adjustable Pole Mount	Bronze	080083458264
YK-XAS-BZ	Yoke Mount	Bronze	080083458288
WM-XAS-BZ	Wall Mount	Bronze	080083458707
ADJPM-XAS-BK	Adjustable Pole Mount	Black	080083458783

Catalog Number	Description	Finish	UPC
YK-XAS-BK	Yoke Mount	Black	080083458806
WM-XAS-BK	Wall Mount	Black	080083458820
HSS-XAS180	House Side Shield Accessory	N/A	080083458721
HSS-XAS300	House Side Shield Accessory	N/A	080083471102

LAS Area and Site Luminaire AREA/SITE

- Two housing sizes for versatile lighting applications
- Automatic dusk-to-dawn area lighting with standard twist-lock photocontrol
- Wide coverage with 10 position field-selectable lumens
- Available with pole-mount arm or adjustable slipfitter for quick installation
- Ideal for parking lots, walkways, and building perimeters



MarketPro Essentials

Catalog Number	Description	Finish	Replaces	CCT	Voltage	Selectable Lumens	Watts	UPC	DLC Product ID
ES LAS45S-T3	T3 Distr., Adjustable Slipfitter Arm	Bronze	450W HID	4000K	120-277V	4,900-20,000	30-153W	080083155804	P1T4HG08
ES LAS45P-T3	T3 Distr., Pole Mount Arm	Bronze	450W HID	4000K	120-277V	4,900-20,000	30-153W	080083248360	P1T4HG08
ES LAS45S-T4	T4 Distr., Adjustable Slipfitter Arm	Bronze	450W HID	4000K	120-277V	4,900-20,000	30-153W	080083155828	PJZT423
ES LAS45P-T4	T4 Distr., Pole Mount Arm	Bronze	450W HID	4000K	120-277V	4,900-20,000	30-153W	080083248384	PJZT423
ES LAS45S-T5	T5 Distr., Adjustable Slipfitter Arm	Bronze	450W HID	4000K	120-277V	4,900-20,000	30-153W	080083155842	PW39PQB3
ES LAS45P-T5	T5 Distr., Pole Mount Arm	Bronze	450W HID	4000K	120-277V	4,900-20,000	30-153W	080083248704	PW39PQB3
ES LAS100S-T3	T3 Distr., Adjustable Slipfitter Arm	Bronze	1,000W HID	4000K	120-277V	8,200-34,000	48-251W	080083155866	PP8AW4F5
ES LAS100P-T3	T3 Distr., Pole Mount Arm	Bronze	1,000W HID	4000K	120-277V	8,200-34,000	48-251W	080083248780	PP8AW4F5
ES LAS100S-T4	T4 Distr., Adjustable Slipfitter Arm	Bronze	1,000W HID	4000K	120-277V	8,200-34,000	48-251W	080083155880	POCHU9AS
ES LAS100P-T4	T4 Distr., Pole Mount Arm	Bronze	1,000W HID	4000K	120-277V	8,200-34,000	48-251W	080083248803	POCHU9AS
ES LAS100S-T5	T5 Distr., Adjustable Slipfitter Arm	Bronze	1,000W HID	4000K	120-277V	8,200-34,000	48-251W	080083155903	PMUFIF4F
ES LAS100P-T5	T5 Distr., Pole Mount Arm	Bronze	1,000W HID	4000K	120-277V	8,200-34,000	48-251W	080083248827	PMUFIF4F

Note: DLC Premium items are noted in bold.

LUMARK WALL MOUNTS

AXC Axcent Luminaire WALL MOUNT

- Full cutoff and refractive LED lens models available in small or large
- Hook-N-Lock mechanism for easy, one-person installation
- Die-cast aluminum construction with energy-efficient illumination
- Fully gasketed optical compartment keeps out contaminants like bugs, water and dust
- Ideal for pathway illumination and floodlighting applications



Catalog Number	Description	Finish	Replaces	CCT	Voltage	Lumens	Watts	UPC	DLC Product ID
AXCS1A	Small Full Cutoff	Carbon Bronze	70W HID	4000K	120-277V	1,806	14	080083887965	S-3SJYCL
AXCS2A	Small Full Cutoff	Carbon Bronze	100W HID	4000K	120-277V	2,561	21	080083887989	S-0Y08BE
AXCS3A	Small Full Cutoff	Carbon Bronze	150W HID	4000K	120-277V	3,537	27	080083888009	S-H7120V
AXCS4A	Small Full Cutoff	Carbon Bronze	250W HID	4000K	120-277V	5,520	44	080083888023	PI16J9U0
AXCS4ARL	Small Refractive Lens	Carbon Bronze	250W HID	4000K	120-277V	5,858	44	080083888030	PPXSGJ9K, PCFKRFBV
AXCS5A	Small Full Cutoff	Carbon Bronze	320W HID	4000K	120-277V	6,300	52	080083888047	PCPDYSZM
AXCL6A	Large Full Cutoff	Carbon Bronze	320W HID	4000K	120-277V	7,594	56	080083811564	PLXS8Y3B
AXCL6ARL	Large Refractive Lens	Carbon Bronze	320W HID	4000K	120-277V	7,809	56	080083811649	PZXNXUOI
AXCL8A	Large Full Cutoff	Carbon Bronze	400W HID	4000K	120-277V	9,696	72	080083811588	PG4TJNY3
AXCL8ARL	Large Refractive Lens	Carbon Bronze	400W HID	4000K	120-277V	9,970	72	080083811663	PBA84MB6
AXCL10A	Large Full Cutoff	Carbon Bronze	400W HID	4000K	120-277V	13,283	102	080083811601	P5X06GE7
AXCL12A	Large Full Cutoff	Carbon Bronze	450W HID	4000K	120-277V	16,823	123	080083811625	PD1N4D39

Note: DLC Premium items are noted in bold.

AXC Back Box Accessories

Catalog Number	Description	Finish	UPC
BB/AXC	Back Box	Carbon Bronze	080083160709
BB/AXC-PC	Back Box with Photocontrol	Carbon Bronze	080083160723

- Features**
- Lumen Select pack allows installer to reduce the light output to 75 or 50%
 - Integrated photocontrol provides maximum energy savings while leveraging
 - Four 1/2" NPT conduit entry points for surface mounted conduit
 - Single die-cast aluminium back box to simultaneously accommodate Axcent small and large housings

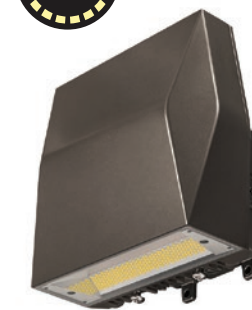

XTOR Crosstour Luminaire WALL MOUNT

- Architectural design with low profile and super bright, energy-efficient LEDs
- Rugged and weather-sealed die-cast construction
- Universal back box with sealed and gasketed optical compartment
- Wall, surface, post, bollard, low-level, inverted, floodlight mounting
- Ideal for multi-use facilities, pathway illumination and building entrances



Catalog Number	Description	Finish	Replaces	CCT	Voltage	Lumens	Watts	UPC	DLC Product ID
XTOR1B	Small Full Cutoff	Carbon Bronze	70W HID	5000K	120-277V	1,418	12	080083777969	PRVAZAZR
XTOR2B	Small Full Cutoff	Carbon Bronze	100W HID	5000K	120-277V	2,135	18	080083778225	PGP4FYV3
XTOR3B	Small Full Cutoff	Carbon Bronze	150W HID	5000K	120-277V	2,751	26	080083778041	PWFZHYJH
XTOR4B	Medium Full Cutoff	Carbon Bronze	250W HID	5000K	120-277V	4,269	38	080083778003	PUJ1NXGY
XTOR6B	Large Full Cutoff	Carbon Bronze	320W HID	5000K	120-277V	6,129	58	080083774807	S-X7BH39
XTOR6B-PC1	Large Full Cutoff with Photocontrol	Carbon Bronze	320W HID	5000K	120-277V	6,129	58	080083774845	S-X7BH39
XTOR6BRL	Large Refractive Lens	Carbon Bronze	320W HID	5000K	120-277V	6,225	58	080083774821	N/A
XTOR8B	Large Full Cutoff	Carbon Bronze	400W HID	5000K	120-277V	8,502	81	080083774814	P5557CRH
XTOR8B-PC1	Large Full Cutoff with Photocontrol	Carbon Bronze	400W HID	5000K	120-277V	8,502	81	080083774869	P5557CRH
XTOR8BRL	Large Refractive Lens	Carbon Bronze	400W HID	5000K	120-277V	8,635	81	080083774852	N/A

CTKR Caretaker Series AREA/SITE

- Rugged die-cast construction for durability and security applications
- Precision optics provide uniform, widespread illumination for maximized visibility
- Wall/pole-mount bracket and integral slipfitter for versatility in mounting
- Versatile universal mounting plate allows quick and easy installation on poles, walls or barns
- Ideal for rural street lighting, perimeter fences, parking areas, loading docks and more



MarketPro Essentials

Catalog Number	Description	Finish	Replaces	CCT	Voltage	Lumens	Watts	UPC	DLC Product ID
ES CTKRV1C	Nano 30W, 4500lm, UNV, Dimming, Photocontrol	Raw	CTKRV1B	4000K	120-277V	4,500	30	080083470990	Pending
ES CTKRV2C	Nano 50W, 6200lm, UNV, Dimming, Photocontrol	Raw	CTKRV2B	4000K	120-277V	6,200	50	080083470983	Pending
ES CTKRV3B	71W, 9700lm, UNV, Dimming, Photocontrol	Raw	250W HID	4000K	120-277V	9,700	71	080083865413	P3POFHML

Note: DLC Premium items are noted in bold.

Accessories

Catalog Number	Description	Finish	UPC
SR-CARETAKER	Small Acrylic Refractor	Clear	080083777969
CNR-CARETAKER NANO	Caretaker 2 Refractor	Clear	080083472574

PRV Prevail Luminaire AREA/SITE

- Sleek, low-profile architectural design with high-performance LEDs and superior efficacy
- Versatile arm mount fits round or square poles for quick installation
- Multiple optical configurations ensure uniform site coverage and optimal pole spacing for energy savings
- Simple retrofit installation for reduced installation time and labor savings
- Ideal for parking lots, campuses, roadways, and walkways



Catalog Number	Description	Finish	Replaces	CCT	Voltage	Lumens	Watts	UPC	DLC Product ID
PRVS-C25-UNV-T3	T3 Distr., STD Arm Mount	Bronze	250W HID	4000K	120-277V	13,183	96	080083897308	S-43K2M0
PRVS-C25-UNV-T4	T4 Distr., STD Arm Mount	Bronze	250W HID	4000K	120-277V	13,140	96	080083897322	S-CXYVFA
PRVS-C40-UNV-T3	T3 Distr., STD Arm Mount	Bronze	400W HID	4000K	120-277V	17,144	131	080083897346	S-YEWL3K
PRVS-C40-UNV-T4	T4 Distr., STD Arm Mount	Bronze	400W HID	4000K	120-277V	17,087	131	080083897360	S-L5W8VA
PRVS-C60-UNV-T3	T3 Distr., STD Arm Mount	Bronze	450W HID	4000K	120-277V	20,050	153	080083897384	S-NS95Z4
PRVS-C60-UNV-T4	T4 Distr., STD Arm Mount	Bronze	450W HID	4000K	120-277V	19,984	153	080083897421	S-RAGPH4

Note: DLC Premium items are noted in bold.

NFFLD Night Falcon Luminaire FLOODLIGHT

- Cost-effective LED floodlight available in medium or large sizes
- Wide 6x6 NEMA beam pattern ensures even illumination with fewer fixtures
- Precision engineered and high-efficiency optics delivers superior uniformity
- Rugged, die-cast aluminum housing for reliable, weatherproof operation
- Ideal for building façades, wall signs, and yard perimeters



Catalog Number	Description	Finish	Replaces	CCT	Voltage	Lumens	Watts	UPC	DLC Product ID
NFFLD-S-C15-T-UNV	Small, Trunnion	Carbon Bronze	150W HID	4000K	120-277V	5,797	51	080083760275	P07DFEUO
NFFLD-S-C15-KNC-UNV	Small, Knuckle	Carbon Bronze	150W HID	4000K	120-277V	5,797	51	080083760268	P07DFEUO
NFFLD-C25-S	Medium, Slipfitter	Carbon Bronze	250W HID	4000K	120-277V	10,530	85	080083801244	P5JBKNFS
NFFLD-C25-T	Medium, Trunnion	Carbon Bronze	250W HID	4000K	120-277V	10,530	85	080083801220	P5JBKNFS
NFFLD-C40-S	Medium, Slipfitter	Carbon Bronze	400W HID	4000K	120-277V	16,932	128	080083801206	PCHBI5F8
NFFLD-C40-T	Medium, Trunnion	Carbon Bronze	400W HID	4000K	120-277V	16,932	128	080083801183	PCHBI5F8
NFFLD-L-C100-S	Large, Slipfitter	Carbon Bronze	1,000W HID	4000K	120-277V	33,941	252	080083800889	P53SWTBG
NFFLD-L-C100-T	Large, Trunnion	Carbon Bronze	1,000W HID	4000K	120-277V	33,941	252	080083800902	P53SWTBG

Note: DLC Premium items are noted in bold.

LUMARK FLOODLIGHTS

NHR Night Harrier Luminaire FLOODLIGHT

- NEMA 3-Pin photocontrol (large) & button-type photocontrol (medium)
- Flexibility with field-selectable 3-color CCT (3000K/4000K/5000K)
- Wide coverage with field-selectable 5,500-43,000 lumens
- Available with slipfitter and trunnion mountings for pole, wall, or ground installations
- Ideal for façades, wall-washing, large signage, and other large areas



Catalog Number	Description	Finish	Replaces	Selectable CCT	Voltage	Selectable Lumens	Watts	UPC	DLC Product ID
NHRS50UT	500W Trunnion Mount	Bronze	70W to 500W HID	3000K-5000K	120-277V	5,500-22,000	40-155W	080083283903	S-2FNDXP
NHRS50US	500W Slipfitter Mount	Bronze	70W to 500W HID	3000K-5000K	120-277V	5,500-22,000	40-155W	080083283910	S-2FNDXP
NHRS50HT	500W Trunnion Mount	Bronze	70W to 500W HID	3000K-5000K	347-480V	5,500-22,000	40-155W	080083283927	S-2FNDXP
NHRS50HS	500W Slipfitter Mount	Bronze	70W to 500W HID	3000K-5000K	347-480V	5,500-22,000	40-155W	080083283934	S-2FNDXP
NHRS50UT-BPC	500W Trunnion Mount, Photocontrol	Bronze	70W to 500W HID	3000K-5000K	120-277V	5,500-22,000	40-155W	080083283941	S-2FNDXP
NHRS50US-BPC	500W Slipfitter Mount, Photocontrol	Bronze	70W to 500W HID	3000K-5000K	120-277V	5,500-22,000	40-155W	080083283958	S-2FNDXP
NHRS100UT	1000W Trunnion Mount	Bronze	500W-1000W HID	3000K-5000K	120-277V	23,000-43,000	40-155W	080083296965	S-Y29CV4
NHRS100US	1000W Slipfitter Mount	Bronze	500W-1000W HID	3000K-5000K	120-277V	23,000-43,000	40-155W	080083296972	S-Y29CV4
NHRS100HT	1000W Trunnion Mount	Bronze	500W-1000W HID	3000K-5000K	347-480V	23,000-43,000	40-155W	080083296989	S-Y29CV4
NHRS100HS	1000W Slipfitter Mount	Bronze	500W-1000W HID	3000K-5000K	347-480V	23,000-43,000	40-155W	080083296996	S-Y29CV4

Note: DLC Premium items are noted in bold.



Resource Center

Cooperlighting.com > Resources

Visit Cooperlighting.com and click on the Resources tab. The Resource Center is a central location of supportive product selection tools, inspirational images and downloadable digital resources.



Product Resources

- Brochures & guides
- Spec sheets
- Installation sheets and guides
- Product Selection Guide

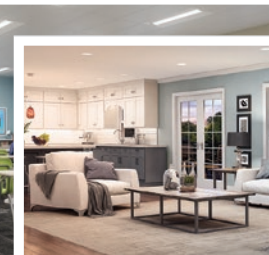

Inspiration

- Application photography
- Product photography & videos
- Case studies
- Logos



Tools

- PRISM Portal
- Energy Incentive Finder
- Photometric IES
- Revit models
- Calculators & audit tools

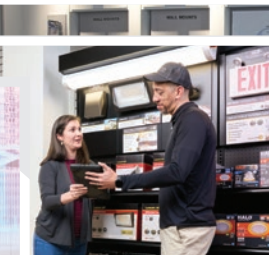

Programs

- MarketPro™
- Quick Spec
- Overstock



Education

- Instructor-led classes
- Free online courses
- Continuing education

Learn. Grow. Visualize.

Explore our one-stop-shop for Cooper Lighting Solutions digital tools.

Explore Our Video Library!

Visit Cooper Lighting Solutions' YouTube page to explore our ever-expanding product video library! Everything you need to know about our innovative product offering can be found here. Get the facts on newly introduced solutions, discover product benefits and watch videos on how to install them. Explore our curated playlists to easily find informative videos by industry-leading brand, market and product category.

youtube.com/cooperlightingsolutions





Security Floodlights



Wall/Ceiling Mounts



Area/Site

HALO Outdoor

Security and utility lighting for residential and commercial applications offering a wide range of features including motion sense, color temperature choices, lumen options, dawn-to-dusk, and more.

HALO OUTDOOR FLOODLIGHTS

TGS Series – Twin Head SECURITY FLOODLIGHT

- Three different brightness levels using Lumen Select Technology
- Durable die-cast aluminum square head with UV resistant lens
- Easy install to wall or eave mounting, with integrated easy connector
- Switch activated, Dusk-to-Dawn, and motion activated models available
- Ideal for security lighting in residential and commercial applications



Dusk-To-Dawn models available

with sensor also available in square head

Catalog Number	Description	Finish	Replaces	CCT	Voltage	Selectable Lumens	Watts	UPC
TGS2S402FRRB	Twin Head Round	Bronze	180W INC	4000K	120V	1,500-2,500	22	080083913053
TGS2S402FRRW	Twin Head Round	White	180W INC	4000K	120V	1,500-2,500	22	080083913374
TGS2S402DRRB	Twin Head Round, D2D	Bronze	180W INC	4000K	120V	1,500-2,500	22	080083913435
TGS2S402DRRW	Twin Head Round, D2D	White	180W INC	4000K	120V	1,500-2,500	22	080083913459
TGS2S402MRRB	Twin Head Round, Motion	Bronze	180W INC	4000K	120V	1,500-2,500	22	080083913510
TGS2S402MRRW	Twin Head Round, Motion	White	180W INC	4000K	120V	1,500-2,500	22	080083913534

TGS Series – Triple Head SECURITY FLOODLIGHT

- Three different brightness levels using Lumen Select Technology
- Durable die-cast aluminum square head with UV resistant lens
- Easy install to wall or eave mounting, with integrated easy connector
- Switch activated, Dusk-to-Dawn, and motion activated models available
- Ideal for security lighting in residential and commercial applications



Dusk-To-Dawn models available

Catalog Number	Description	Finish	Replaces	CCT	Voltage	Selectable Lumens	Watts	UPC
TGS3S403FRRW	Triple Head Round	White	270W INC	4000K	120V	2,000-3,000	27	080083913619
TGS3S403DRRB	Triple Head Round, D2D	Bronze	270W INC	4000K	120V	2,000-3,000	27	080083913671
TGS3S403DRRW	Triple Head Round, D2D	White	270W INC	4000K	120V	2,000-3,000	27	080083913695

TGS Series – Single Head High Output SECURITY FLOODLIGHT

- Three different brightness levels using Lumen Select Technology
- Durable die-cast aluminum square head with UV resistant lens
- Easy install to wall or eave mounting, with integrated easy connector
- Switch activated, Dusk-to-Dawn, and motion activated models available
- Ideal for security lighting in residential and commercial applications



Dusk-To-Dawn models available

with sensor

Catalog Number	Description	Finish	Replaces	CCT	Voltage	Selectable Lumens	Watts	UPC
TGS5S401DSCB	Single Head High Output Square, D2D	Bronze	175W HID	4000K	120-277V	2,700-5,800	50	080083256013
TGS5S401MSCW	Single Head High Output Square, Motion	White	175W HID	4000K	120-277V	2,700-5,800	50	080083260065

HALO OUTDOOR FLOODLIGHTS

SEC – Hardwired SECURITY FLOODLIGHT

- Available in Single, Twin and Triple Head Fixtures
- Wide coverage with field-selectable lumens up to 3,500
- Choose from motion, dusk-to-dawn, or motion + dusk-to-dawn modes
- Adjustable heads for targeted coverage
- Ideal for residential applications like backyards, barns, garages, etc



Catalog Number	Description	Finish	Selectable CCT	Voltage	Selectable Lumens	Watts	UPC
SEC1HSHWMBLK	Single Head Hardwired, Motion, D2D	Black	2700-6500K	120V	360-1,500	3-12	080083303731
SEC1HSHWMWH	Single Head Hardwired, Motion, D2D	White	2700-6500K	120V	360-1,500	3-12	080083304325
SEC2HSHWMBLK	Twin Head Hardwired, Motion, D2D (up to 2,500 Lumens)	Black	2700-6500K	120V	560-2,500	5-20	080083304103
SEC2HSHWMWH	Twin Head Hardwired, Motion, D2D (up to 2,500 Lumens)	White	2700-6500K	120V	560-2,500	5-20	080083304349
SEC3HSHWMBLK	Triple Head Hardwired, Motion, D2D (up to 3,500 Lumens)	Black	2700-5000K	120V	1,480-3,500	7-28	080083304127
SEC3HSHWMWH	Triple Head Hardwired, Motion, D2D (up to 3,500 Lumens)	White	2700-5000K	120V	1,480-3,500	7-28	080083304363

SEC – Plug & Cord SECURITY FLOODLIGHT

- Available in Twin Head Fixture only
- Wide coverage with field-selectable lumens up to 3,500
- Choose from motion, dusk-to-dawn, or motion + dusk-to-dawn modes
- Adjustable heads for targeted coverage
- Ideal for residential applications like backyards, barns, garages, etc



Catalog Number	Description	Finish	Selectable CCT	Voltage	Selectable Lumens	Watts	UPC
SEC2HSPUGMBLK	Twin Head AC Plug, Motion, D2D (up to 2,500 Lumens)	Black	2700-6500K	120V	560-2,500	5-20	080083304141
SEC2HSPUGMWH	Twin Head AC Plug, Motion, D2D (up to 2,500 Lumens)	White	2700-6500K	120V	560-2,500	5-20	080083304387

SEC – Battery Powered SECURITY FLOODLIGHT

- Available in Single, Twin and Triple Head Fixtures
- Wide coverage with field-selectable lumens up to 3,500
- Choose from motion, dusk-to-dawn, or motion + dusk-to-dawn modes
- Adjustable heads for targeted coverage
- Ideal for residential applications like backyards, barns, garages, etc



Catalog Number	Description	Finish	Selectable CCT	Selectable Lumens	Watts	UPC
SEC1HSBATMBLK	Single Head Battery, Motion, D2D	Black	2700-6500K	200-800	10	080083304165
SEC1HSBATMWH	Single Head Battery, Motion, D2D	White	2700-6500K	200-800	10	080083304400
SEC2HSBATMBLK	Twin Head Battery, Motion, D2D (up to 1,200 Lumens)	Black	2700-6500K	300-1,200	15	080083304189
SEC2HSBATMWH	Twin Head Battery, Motion, D2D (up to 1,200 Lumens)	White	2700-6500K	300-1,200	15	080083304424
SEC3HSBATMBLK	Triple Head Battery, Motion, D2D (up to 1,500 Lumens)	Black	2700-6500K	375-1,500	17	080083304202
SEC3HSBATMWH	Triple Head Battery, Motion, D2D (up to 1,500 Lumens)	White	2700-6500K	375-1,500	17	080083304448

HALO OUTDOOR FLOODLIGHTS

SEC – Solar Powered SECURITY FLOODLIGHT

- Available in Single, Twin and Triple Head Fixtures
- Wide coverage with field-selectable lumens up to 3,500
- Choose from motion, dusk-to-dawn, or motion + dusk-to-dawn modes
- Adjustable heads for targeted coverage
- Ideal for residential applications like backyards, barns, garages, etc



Catalog Number	Description	Finish	Selectable CCT	Selectable Lumens	Watts	UPC
SEC1HSSOLMBLK	Single Head Solar, Motion, D2D (up to 1,000 Lumens)	Black	2700-6500K	250-1,000	9	080083304226
SEC1HSSOLMWH	Single Head Solar, Motion, D2D (up to 1,000 Lumens)	White	2700-6500K	250-1,000	9	080083304462
SEC2HSSOLMBLK	Twin Head Solar, Motion, D2D (up to 1,500 Lumens)	Black	2700-6500K	375-1,500	13	080083304240
SEC2HSSOLMWH	Twin Head Solar, Motion, D2D (up to 1,500 Lumens)	White	2700-6500K	375-1,500	13	080083304486
SEC3HSSOLMBLK	Triple Head Solar, Motion, D2D (up to 2,000 Lumens)	Black	2700-6500K	500-2,000	16	080083304264
SEC3HSSOLMWH	Triple Head Solar, Motion, D2D (up to 2,000 Lumens)	White	2700-6500K	500-2,000	16	080083304509

FGS SECURITY FLOODLIGHT

- Flexibility with field-selectable 5-color CCT (3000K/3500K/4000K/5000K/6500K)
- 2,000 to 6,000 selectable lumens range with low, medium, and high outputs
- Dusk to Dawn Photocell and motion with standby options available
- Glare-free UV, & impact resistant PC prismatic lens
- Ideal for residential applications like backyards, barns, garages, etc



Catalog Number	Description	Finish	Replaces	Selectable CCT	Voltage	Selectable Lumens	Watts	UPC
FGS30CLD2DB	Single Head High Output Square, D2D	Bronze	180W HID	3000K-6500K	120V	2,000-3,000	12-27	080083292936
FGS30CLD2DW	Single Head High Output Square, D2D	White	180W HID	3000K-6500K	120V	2,000-3,000	12-27	080083292943
FGS60CLMTNB	Single Head High Output Square, Motion	Bronze	270W HID	3000K-6500K	120-277V	2,000-6,000	18-45	080083292967
FGS60CLMTNW	Single Head High Output Square, Motion	White	270W HID	3000K-6500K	120-277V	2,000-6,000	18-45	080083292950

HALO OUTDOOR WALL MOUNTS

BKHD WALL/CEILING MOUNT

- Flexibility with field-selectable 5-color CCT (3000K/3500K/4000K/5000K/6500K)
- Wide coverage with field-selectable lumens up to 3,500
- Integrated Photocell for Dusk to Dawn operation with manual switch operation
- IP65 rated against dust and water; Glare-free UV, & impact resistant PC prismatic lens
- Durable die-cast aluminum housing suitable for wet locations



Catalog Number	Description	Finish	Replaces	Selectable CCT	Voltage	Selectable Lumens	Watts	UPC
BKHDR150CLD2D	Bulk Head Wall/Ceiling Mount, D2D	Bronze	150W HID	3,000-6,500K	120-277V	2,100-3,500	18-30	080083293032

Wall Cylinder WALL MOUNT

- Flexibility with field-selectable 5-color CCT (3000K/3500K/4000K/5000K/6500K)
- Integrated Photocell for Dusk to Dawn operation with manual switch operation
- IP65 rated against dust and water
- Durable die-cast aluminum housing suitable for wet locations
- Ideal for commercial applications like warehouses, building entrances, etc



Catalog Number	Description	Finish	Replaces	Selectable CCT	Voltage	Lumens	Watts	UPC	DLC Product ID
CYLNR20CLD2D	Wall Mount Luminaire, Round, D2D	Bronze	70W HID	2700K-5000K	120-277V	4,000	18-30	080083293049	Pending
CYLNS20CLD2D	Wall Mount Luminaire, Square, D2D	Bronze	70W HID	2700K-5000K	120-277V	4,000	18-30	080083293056	Pending

Mini Wall Pack WALL MOUNT

- Flexibility with field-selectable 3-color CCT (3000K/4000K/5000K)
- Two lumen packages available; 2000 and 4000 lumens
- Integrated Photocell for Dusk to Dawn operation with manual switch operation
- Durable die-cast aluminum housing suitable for wet locations
- Glare-free UV, & impact resistant PC prismatic lens



Catalog Number	Description	Finish	Replaces	Selectable CCT	Voltage	Lumens	Watts	UPC	DLC Product ID
MWP20FSUNVDBZ	Mini LED Wall Pack, D2D	Bronze	70W INC	3000K-5000K	120-277V	2,000	15	080083260805	Pending
MWP40FSUNVDBZ	Mini LED Wall Pack, D2D	Bronze	150W INC	3000K-5000K	120-277V	4,000	30	080083260782	Pending

HALO OUTDOOR WALL MOUNTS

FE Series WALL MOUNT

- Replaces up to 60W/75W Incandescent or 13W/26W CFL fixtures
- Three lumen packages available; 800, 1000 and 1200 lumens in 2 color finishes
- Highly durable & corrosion resistant polycarbonate construction
- Built in, switch operated photocontrol for Dusk-to-Dawn operation & motion sensor
- Perfect security lighting for residential and light commercial applications



Catalog Number	Description	Finish	Replaces	CCT	Voltage	Lumens	Watts	UPC
FE08A40FDB	Jelly Jar, D2D	Bronze	60/75W	4000K	120V	800	8	080083265152
FE12S40FDB	Jelly Jar, D2D	Bronze	60/75W	4000K	120V	1,200	11	080083241989
FE12S40FDW	Jelly Jar, D2D	White	60/75W	4000K	120V	1,000	11	080083242009
FE10A35GLMB	Jelly Jar, Motion	Bronze	60/75W	3500K	120V	1,000	13	080083242023
FE10A35GLMW	Jelly Jar, Motion	White	60/75W	3500K	120V	1,000	13	080083242047

Solar Motion Wedge WALL MOUNT

- Motion sensor with dual light levels: full brightness when motion is detected, and half brightness when no motion is detected
- 4000K Cool White maintenance free LED's with 50,000 hours life
- 3 Adjustable Time Out settings – 30s, 60s, & 90s
- Durable polycarbonate housing with frosted lens for smooth, glare-free lighting



Catalog Number	Description	Finish	Replaces	CCT	Lumens	UPC
SWL0540W	Solar Wedge, motion	White	40W INC	4000K	500	080083242061
SWL0540B	Solar Wedge, motion	Bronze	40W INC	4000K	500	080083242108
SWL0840W	Solar Wedge, motion	White	70W INC	4000K	800	080083242085
SWL0840B	Solar Wedge, motion	Bronze	70W INC	4000K	800	080083242122

HALO OUTDOOR AREA/SITE

SBL Solar AREA/SITE

- 5000K bright cool white light is optimal for security lighting
- 3 operating modes: Motion, Dusk to Dawn, and Motion + Dusk to Dawn, with remote control and On/Off functions included
- 3 Adjustable Time Out settings – 30s, 60s, & 90s
- UV & impact resistant prismatic drop lens



Catalog Number	Description	Finish	Replaces	CCT	Lumens	UPC
SBL10A50GY	Solar barn light, Motion, D2D	Gray	80W INC	5000K	1,000	080083260461
SBL15A50GY	Solar barn light, Motion, D2D	Gray	150W INC	5000K	1,500	080083260485
SBL30A50GY	Solar barn light, Motion, D2D	Gray	300W INC	5000K	3,000	080083260508

VT Series VAPOR PROOF

- LED or incandescent options available
- Durable die-cast aluminum housing and cage provides protection against vandalism
- Vapor tight IP65 rating protects against dust and moisture
- Versatile mounting options – Wall, Ceiling and Post
- Frosted glass lens provides smooth and even light distribution



Catalog Number	Description	Finish	Replaces	CCT	Voltage	Lumens	Watts	UPC
VT100G	100W Incandescent Vapor Tight	Raw	N/A	2700K	120V	1,600	100	080083757879
VT0840L	800 Lumen, 4000K, LED Vapor Tight	Raw	60W INC	4000K	120-277V	800	9	044427550113

PRISM PORTAL

Our Central Hub for Distributor Business.

Cooper Lighting Solutions PRISM Portal is a digital hub for authorized partners to self-serve reliable product data, place orders, and manage orders. It offers hassle-free access to price and availability, spec sheets, order tracking, invoices, and more!

- **Advanced Product Search at Your Fingertips**
- **Real-Time Pricing & Availability**
- **Seamless Online Order Entry**
- **Comprehensive Order Status Tracking**

[CLICK HERE](#) to register for PRISM Portal

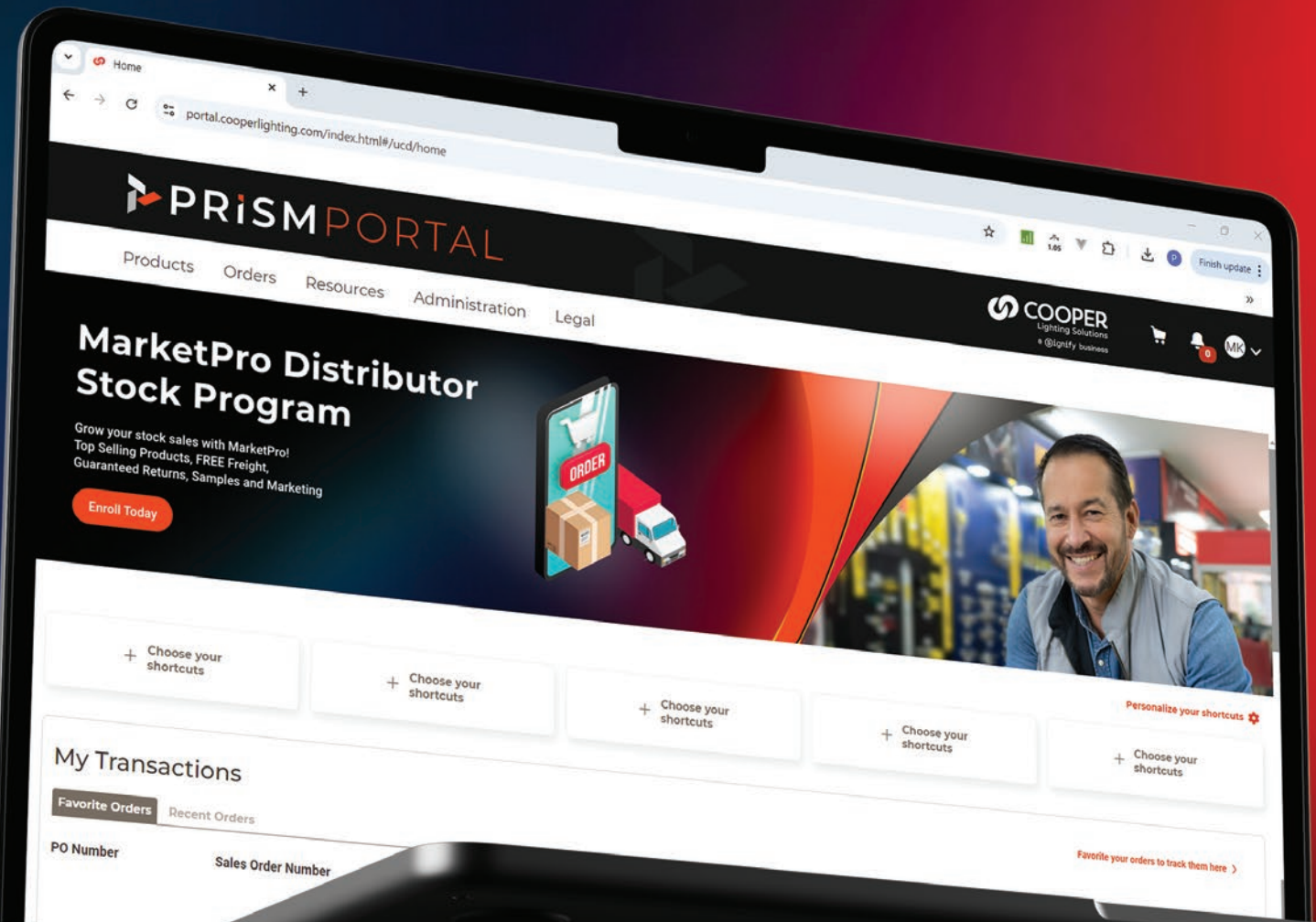

Explore the PRISM Portal for Streamlined Business Solutions.

Lighting & Controls

STOCK PRODUCT GUIDE

LIGHTING BRANDS

Ametrix
AtLite
Corelite
Ephesus
Fail-Safe
HALO
HALO Commercial
Invue
iO
Iris
Lumark
LumarkAP
Lumière
McGraw-Edison
Metalux
MWS
Nemalux
NeoRay
Portfolio
PrentaLux - 3D Printed Lighting
RSA
Shaper
Streetworks
Sure-Lites

CONTROLS BRANDS

Greengate
Fifth Light
Intelligent Lighting Controls

CONNECTED LIGHTING SYSTEMS AND SMART SPACES PLATFORM

WaveLinx
Trellix Infrastructure



Cooper Lighting Solutions
1121 Highway 74 South
Peachtree City, GA 30269
P: 770-486-4800
www.cooperlighting.com

Canada Sales
5925 McLaughlin Road
Mississauga, Ontario L5R 1B8
P: 905-501-3000
F: 905-501-3172

© 2026 Cooper Lighting Solutions
All Rights Reserved
Printed in USA
Publication No. CA5250233_Q2 Digital
April 2026

Cooper Lighting Solutions is a registered trademark.

All other trademarks are property of their respective owners.

Product availability, specifications, and compliances are subject to change without notice.