

# PrentaLux

Product Look Book

Personalized Light, Reimagined

00

## ABOUT US

Learn more about our story and proposition.

PP 3 - 4

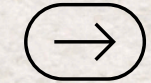

01

## CYLINDERS

Beautiful meets functional.

PP 5 - 17



02

## HIGH BAY

A modern twist on classic industrial lighting.

PP 18 - 23

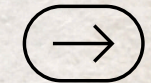

03

## PERFORMANCE INTEGRAL LED PENDANTS

High-performance and stylish lighting solutions.

PP 24 - 54

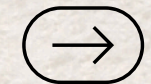

04

## DECORATIVE LAMP-BASED PENDANTS

Small, medium and large modern decorative pendants with circularity in mind.

PP 55 - 71

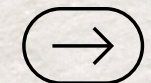

05

## TAILORED SOLUTIONS

Delivered fast. At scale.

PP 72 - 82

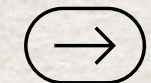



## Personalized Light, Reimagined

PrentaLux is lighting the way to the future with innovative and artistic lighting solutions created using 3D printing.

Our proprietary 3D printing process is redefining personalized lighting design, providing designers with more creative freedom. And our sustainable practices—using recycled or mass-balanced, bio-circular plastics, for example—are helping lead the way to a brighter future.

PrentaLux offers its own collection of distinctive lighting as well as collaborations with other Cooper Lighting Solutions brands, infusing their products with sustainable materials and delivering the kind of fast, efficient, and reliable results for which PrentaLux is known.

### Contact

For product inquiries, custom requests, or partnership opportunities, [click here.](#)

# VALUE THAT MATTERS

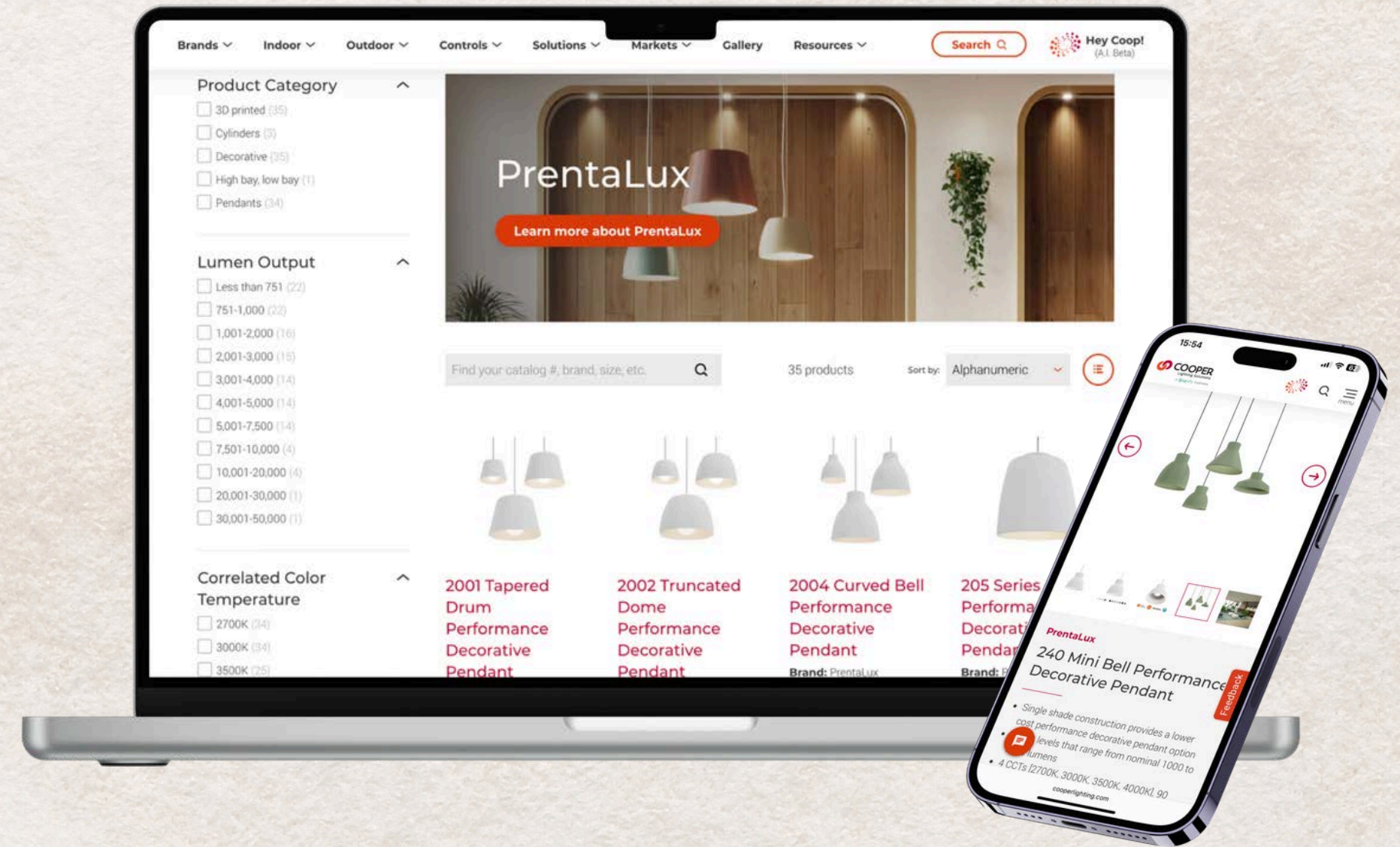

## 1. PERSONALIZATION



Innovative lighting with unique shapes, customizable options, and easy installation, tailored for modern spaces and special projects.

## 2. PERFORMANCE



High-performing, energy-efficient luminaires seamlessly integrate with lighting systems, ensuring reliability and ease of configuration.

## 3. SUSTAINABILITY



Eco-friendly solutions using recycled materials, circular design, and local production to reduce CO<sub>2</sub> emissions and waste.

## 4. RELIABILITY



Transparent, fast, and reliable, backed by global partnerships and the excellence of Signify, the world leader in lighting. Made in the USA.

# CYLINDERS

Beautiful Meets Functional 

PrentaLux is transforming cylinder luminaires into creative canvases with the Sustainable LED Cylinders.

Enjoy extensive customization opportunities with an array of colors and textures. These efficient cylinders fulfill both functional and aesthetic needs. Manufactured using 3D printing technology with at least 75% recycled or bio-circular materials, PrentaLux cylinders are environmentally friendly and comply with Buy American standards. Ideal for hospitality, retail, and office settings, they can be used individually for accent lighting or grouped for striking installations.



# PrentaLux

Sustainable LED Cylinder - 2", 3", & 6" Pendants,  
2" Surface & Wall Mount

# Sustainable LED Cylinder - 2", 3" and 6" Pendants: **Applications**

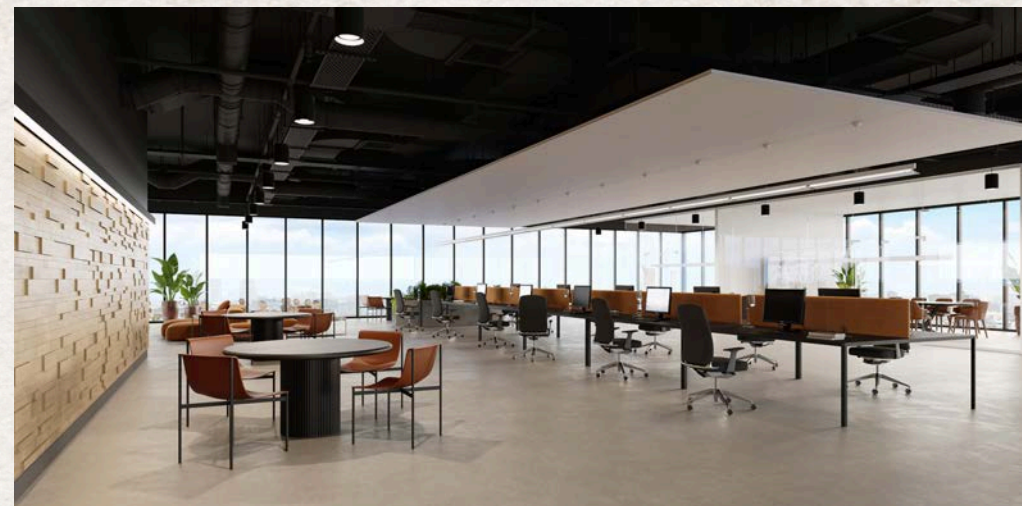
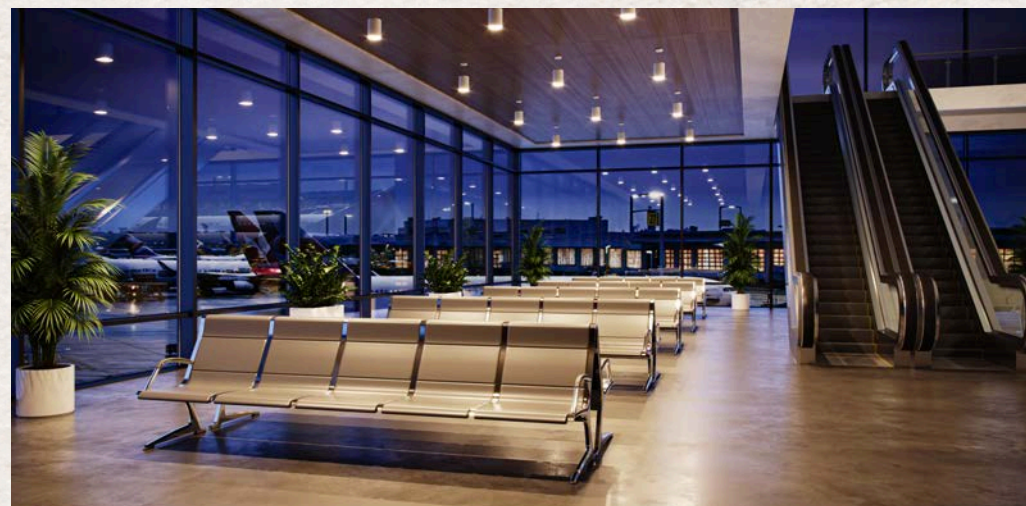
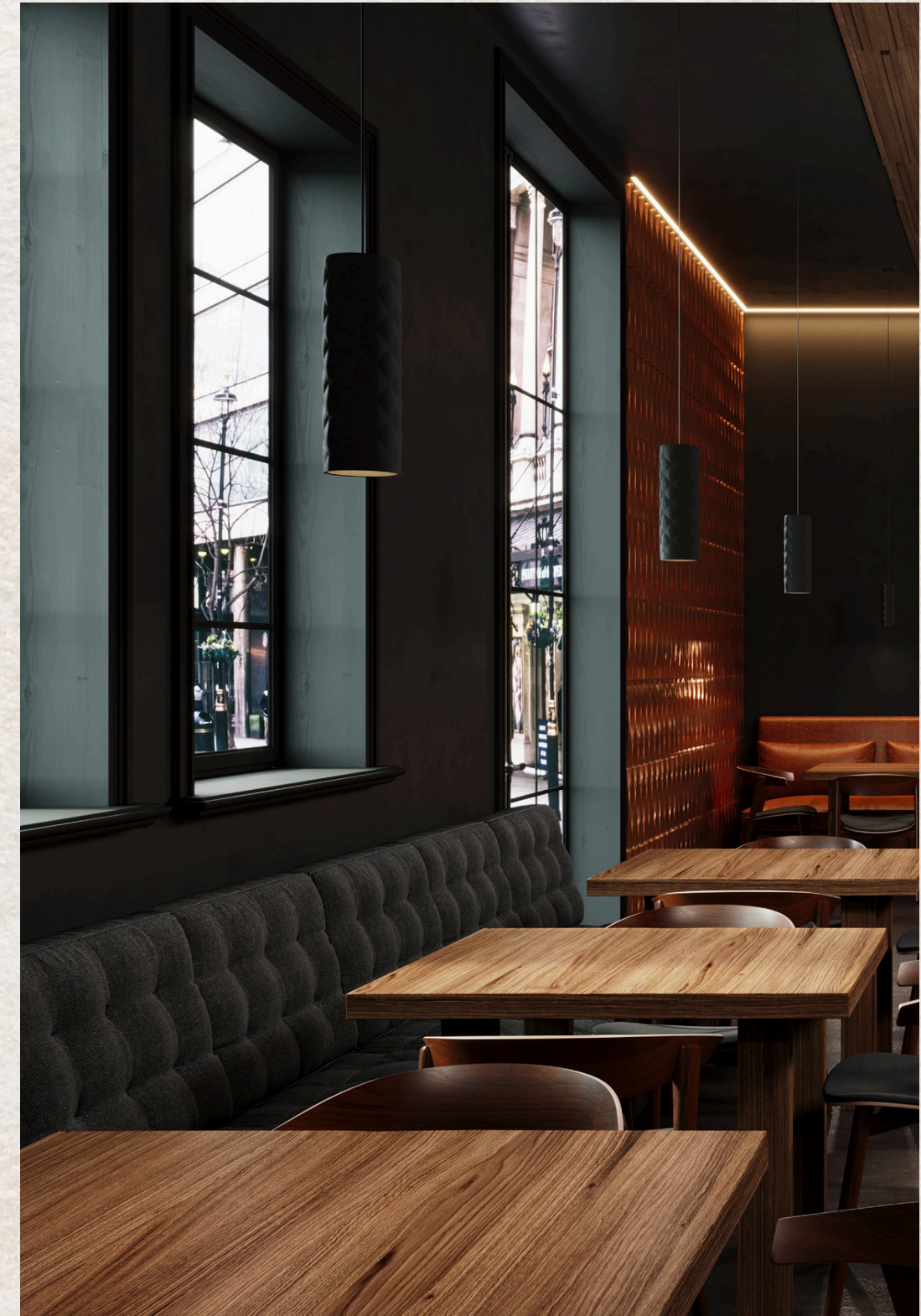

Click or scan to see complete size, color and texture options on our online configurator



# Sustainable LED Cylinder - 2" Surface & Wall Mount: **Applications**

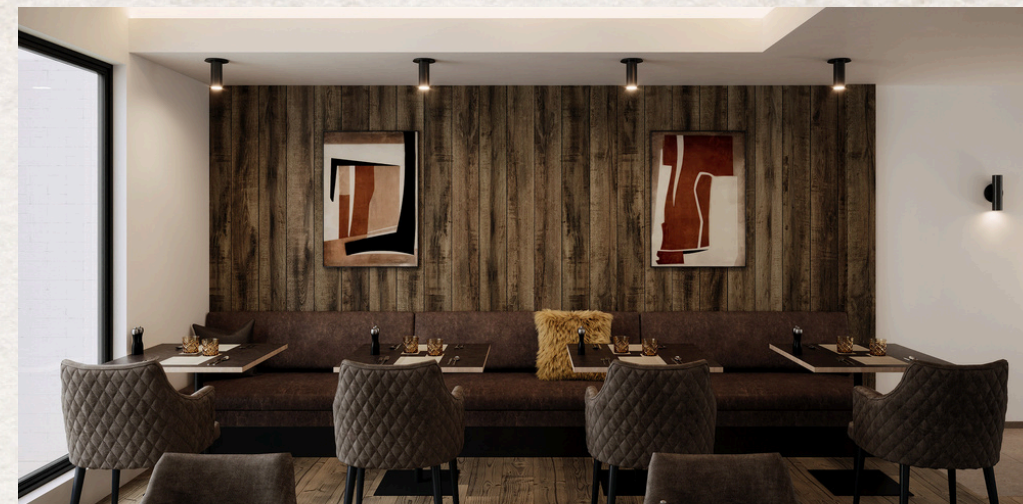
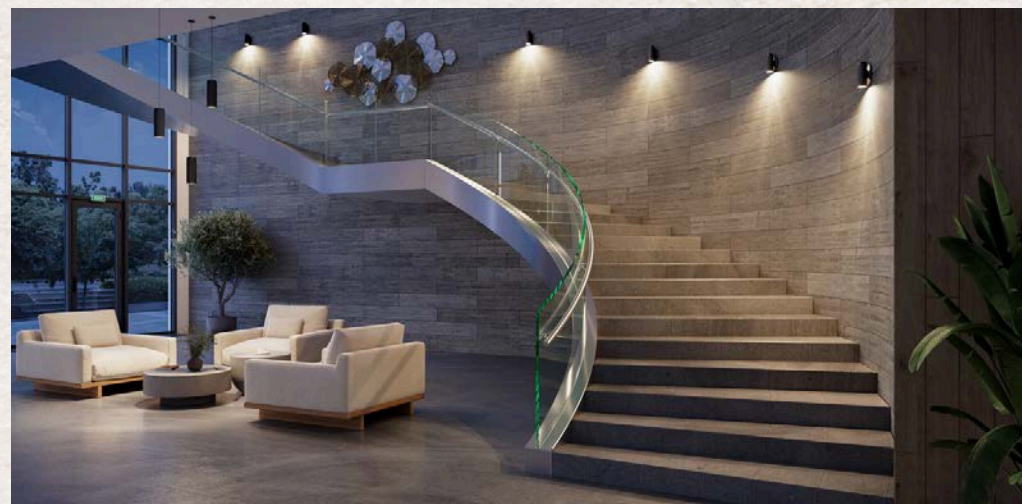

Click or scan to see complete size, color and texture options on our online configurator

**2" Surface Mount**



**2" Wall Mount**



# Sustainable LED Cylinder - 2", 3" and 6" Pendants: **Closeups**

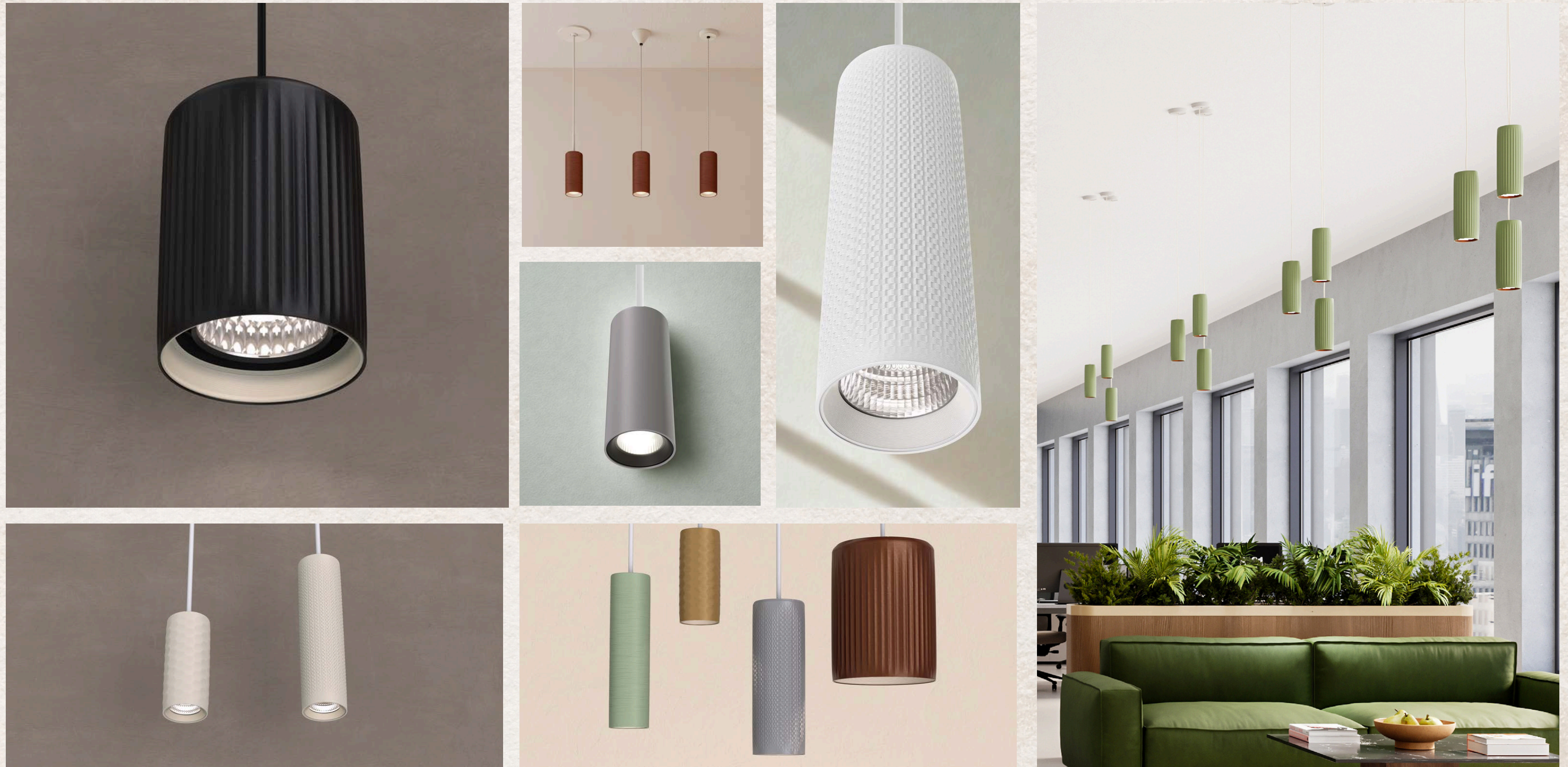

2"

3"

6"



Click or scan to see complete size, color and texture options on our online configurator

# Sustainable LED Cylinder - 2" Surface and Wall Mount: **Closeups**

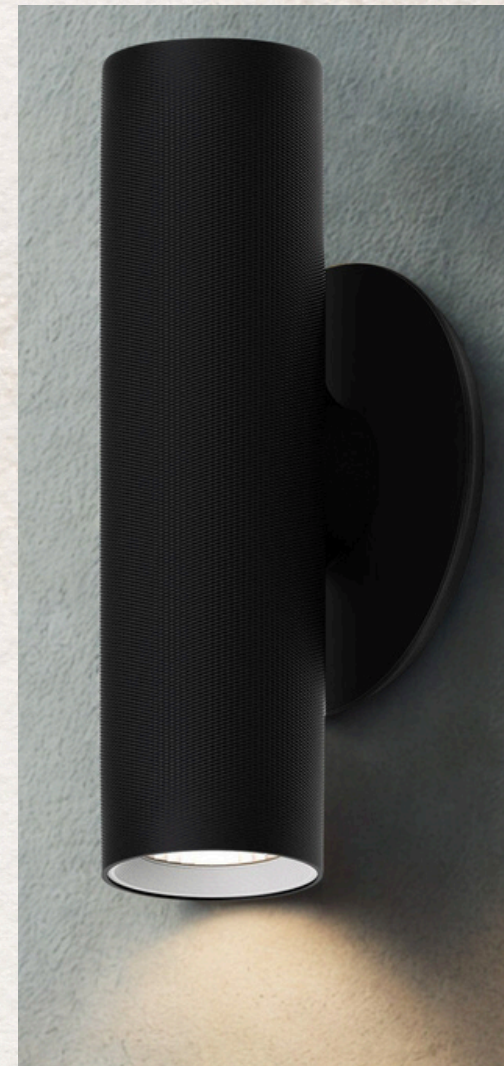

**2" Surface Mount**

**2" Wall Mount**

Click or scan to see complete size, color and texture options on our online configurator







# Sustainable LED Cylinder - 2", 3" and 6" Pendants

## Key Specifications

- Rich pallet of housing colors and textures - Standard & On-Demand
- Wide range of beam angles to choose from
- 90+ CRI standard with 4 CCT options (2700K, 3000K, 3500K, 4000K)
- Efficacy up to 169 lm/w
- Lumens: 1000-7400+ Lumens
- Dimming options: 0-10V and ELV 100-5% (2" cylinder); 0-10V, 100-1% (3" and 6" cylinders)
- Lumen Maintenance: TM-21-11 (60,000 Hours) >80%

## Operational & Certifications

**Compliance & Certifications:** cULus, RoHS, Declare, BAA Compliant, ISCC certified filament

**Application Rating:** Suitable for Damp Locations

**Protection Class:** IP20 / IK02

**Warranty:** 5 Year Limited

## Electrical

**Input Voltage:** 120-277V

**Frequency:** 50-60 Hz

**Power Factor:** 0.9

**Dimming:** 0-10V and ELV reverse phase, 100-5%

### Dimensions - 2"

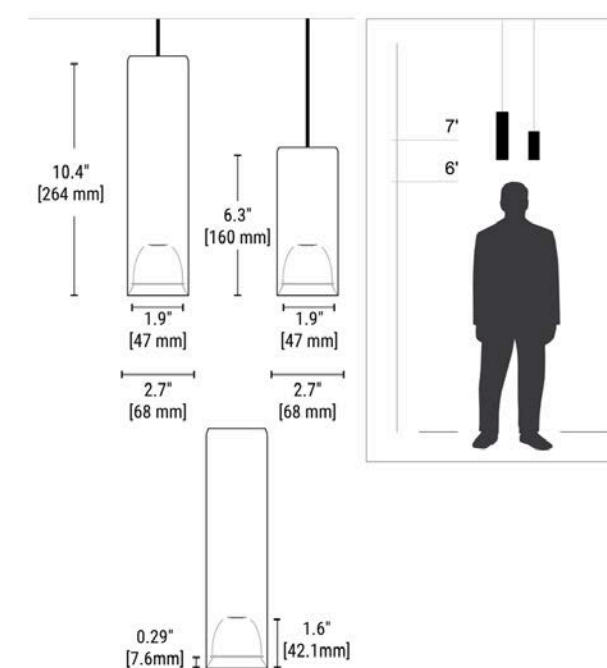

### Dimensions - 3"

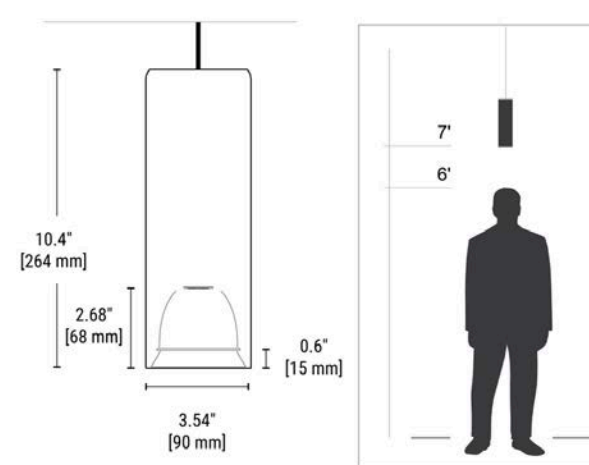

### Dimensions - 6"

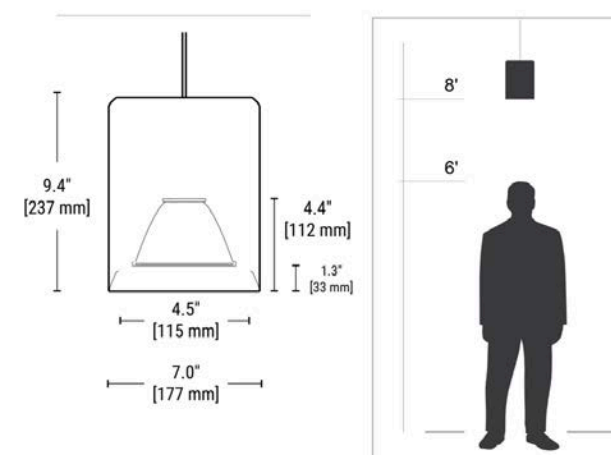

Filament only



# Sustainable LED Cylinder - 2" Surface & Wall Mount

## Key Specifications

- 7 housing texture options available (Surface mount)
- 6 housing texture options available (Wall mount)
- 9 standard housing color options and 5 inner trim color options, additional on-demand colors available
- 90+ CRI standard with 4 CCT options (2700K, 3000K, 3500K, 4000K)
- 2 Light Levels (Surface): 1000, 1500 nominal lumens
- 3 Light Levels (Wall): 1000, 1500, 2000 (DI, 10" Tall only) nominal lumens
- Integral driver with two dimming protocols: 0-10V (120-277V) and ELV reverse phase (120V)

## Operational & Certifications

**Compliance & Certifications:** cULus, RoHS, Declare, BAA Compliant, ISCC certified filament  
**Application Ratings:** Suitable for Damp Locations  
**Protection Class:** IK02 impact rated  
**Warranty:** 5 Year Limited

## Electrical

**Input Voltage:** 120-277V  
**Frequency:** 50-60 Hz  
**Power Factor:** 0.9  
**Dimming:** 0-10V and ELV reverse phase, 100-5%

## Dimensions - 2" Surface Mount

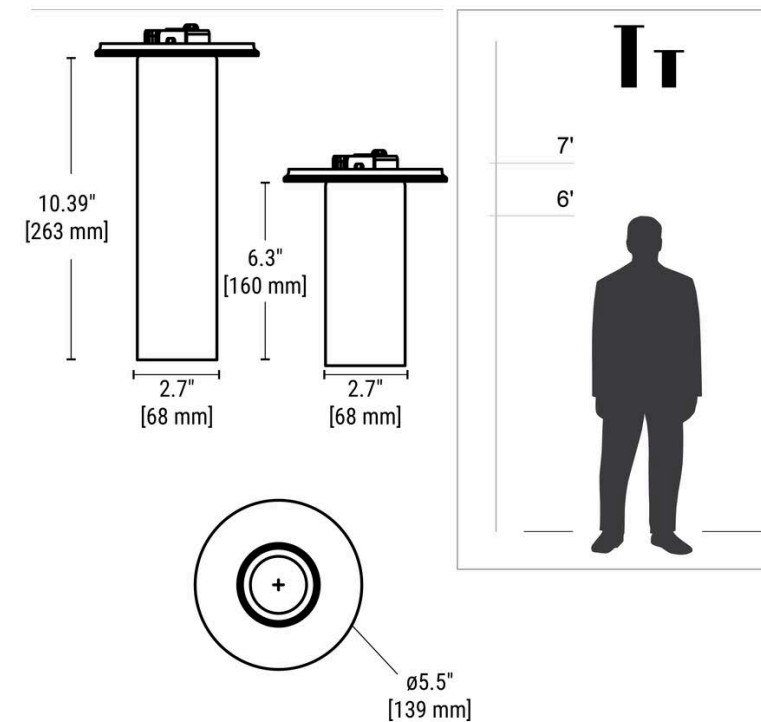

## Dimensions - 2" Wall Mount

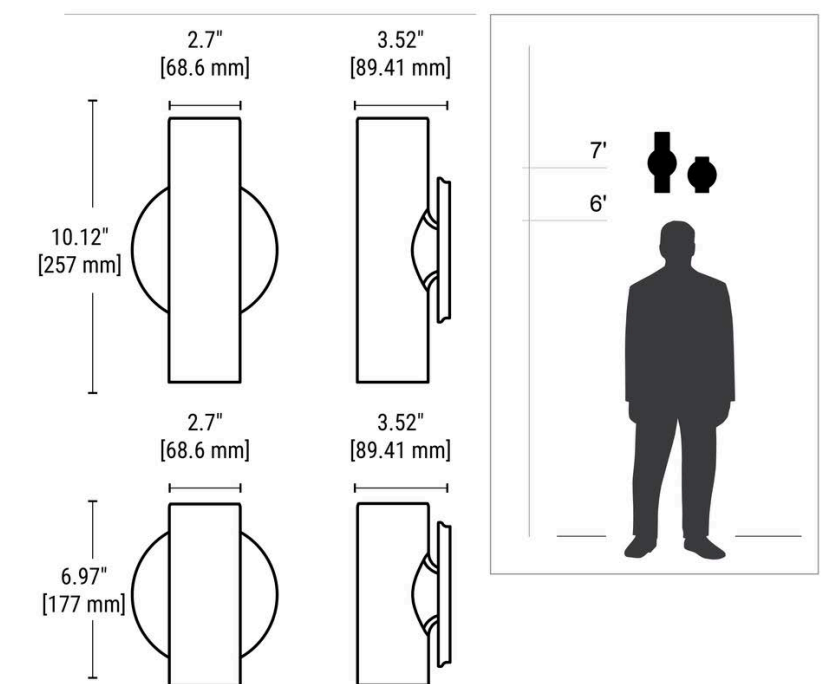

Filament only



[Table of Contents](#)

# Sustainable LED Cylinder - 2", 3" and 6" Pendants

## Standard Housing Colors



## Trim Colors



## On-Demand Colors

These On-Demand color options for housing and trims may have extended lead times and/or additional costs.



## Housing Textures

Close up view of textures

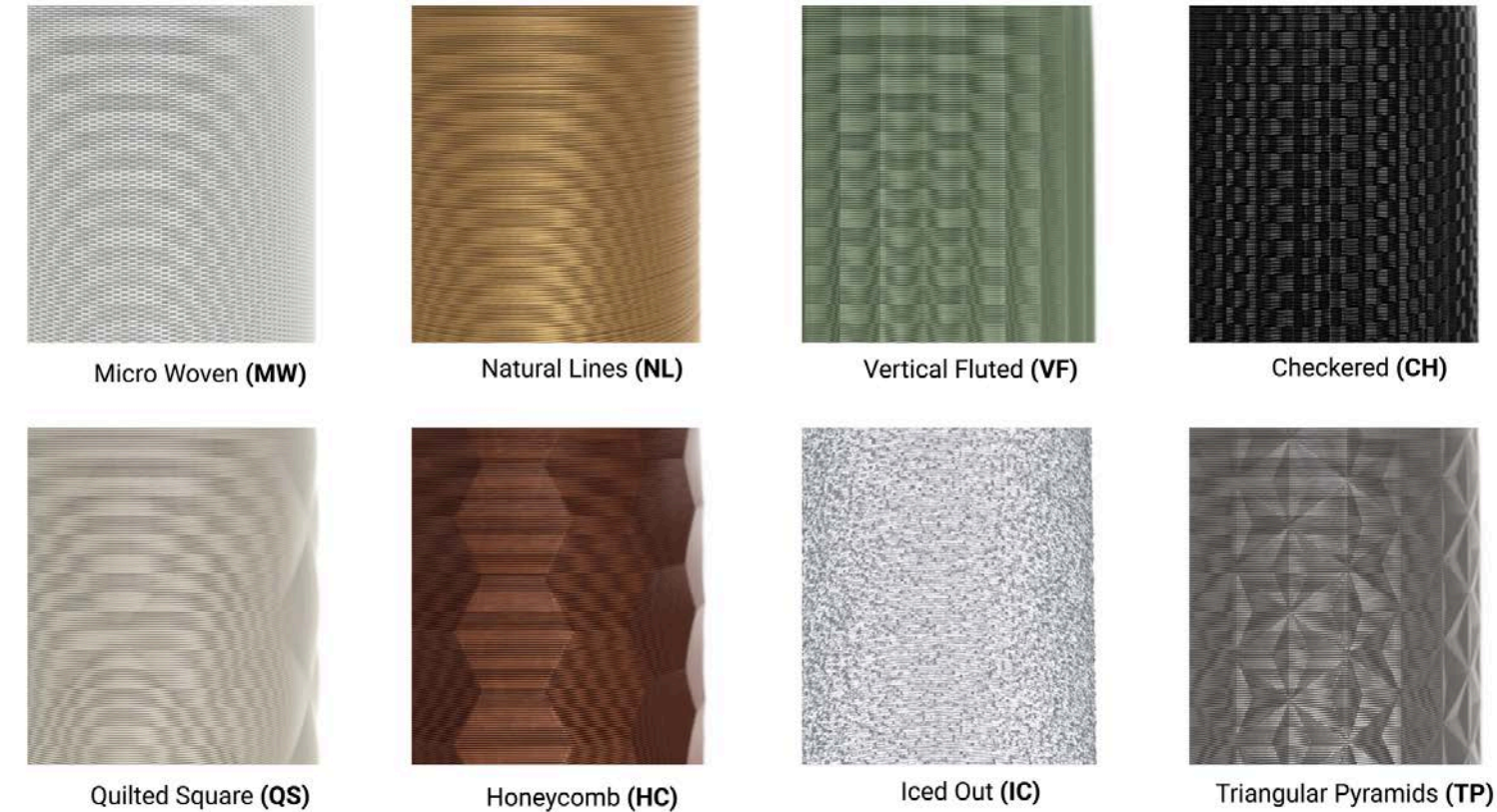

## Configuration Page



[Click here for more dimensions and extra specifications.](#)

Visit [www.signify.com/warranties](http://www.signify.com/warranties) for complete warranty information.

[Table of Contents](#)

# Sustainable LED Cylinder - 2" Surface & Wall Mount

## Standard Housing Colors



## Trim Colors



## On-Demand Colors

These On-Demand color options for housing and trims may have extended lead times and/or additional costs.



## Housing Textures

Close up view of textures



*Available for Surface Mount only.*

## Configuration Page

**2" Surface Mount** • **2" Wall Mount**



**[Click here for more dimensions and extra specifications.](#)**

Visit [www.signify.com/warranties](http://www.signify.com/warranties) for complete warranty information.

[Table of Contents](#)

Explore our  
Sustainable LED Cylinder  
Lookbook

---



[Scan the QR](#)  
[or click here](#)

# HIGH BAY

A Modern Twist on Classic Industrial Lighting 

High bay lighting never looked so good! PrentaLux High Bays combine stylish modern shapes with superior performance. Crafted from sustainable materials and proudly printed and assembled in USA, this high bay offers multiple high-intensity lumen packages, making it ideal for big-box retail, grocery stores, car dealerships, and other high-ceiling applications.



# PrentaLux | Decorative High Bay

## Decorative High Bay Gen 2: Applications



## Decorative High Bay Gen 2: **Closeups**

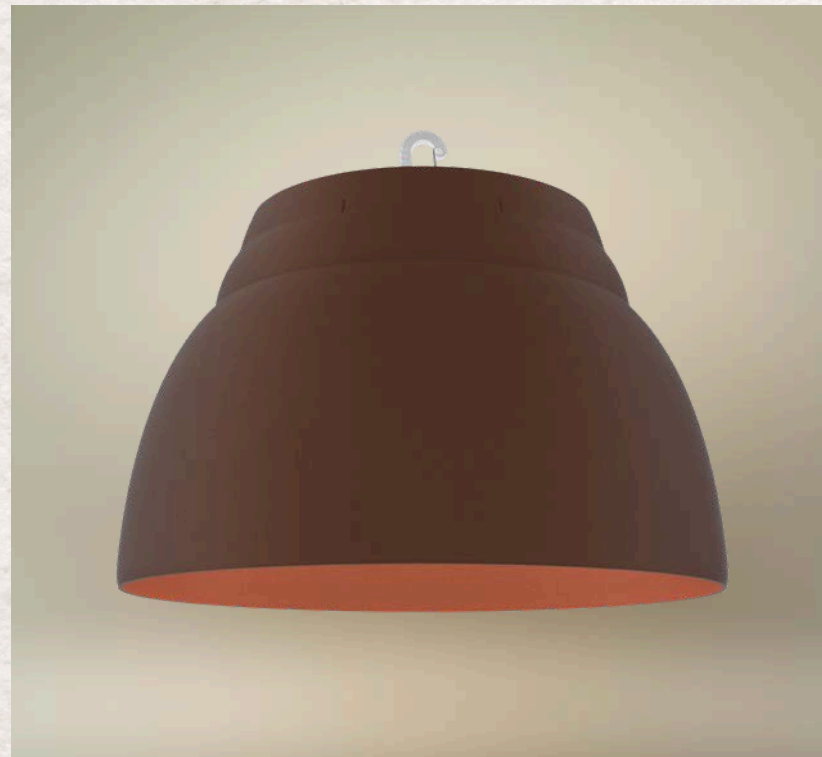

# Decorative High Bay Gen 2

## Key Specifications

- PrentaLux Decorative High Bay with Opaque or Translucent shades in various color offerings
- Selectable Lumen/Power performance up to 36,000 lumens
- 5 Color Selectable CCT - 3000/3500/4000/5000/6500K
- Field selectable distribution - Narrow, Medium, or Wide
- Sensor ready port for quick plug and play install
- 120-347 operating range with 6kV surge protection
- NEMA 4X, IP65 and NSF rated
- IP65 rated lens and driver enclosure
- 10ft power and dimming cords for easy installation

## Operational & Certifications

**Compliance & Certifications:** UL certified filament, UL recognized components, ISCC certified filament, RoHS

**Application Rating:** Listed for 25°C ambient environments

**Protection Class:** IK02, NEMA 4X, IP65 and NSF rated

**Warranty:** 5 Year Limited

## Electrical

**Input Voltage:** 120V-347V

**Frequency:** 50-60 Hz

**Power Factor:** >0.9

**Dimming:** 0-10V dimming, 10% standard

## Dimensions - Small

**PRLX-UHBS2-1218**  
(Small PrentaLux High Bay)

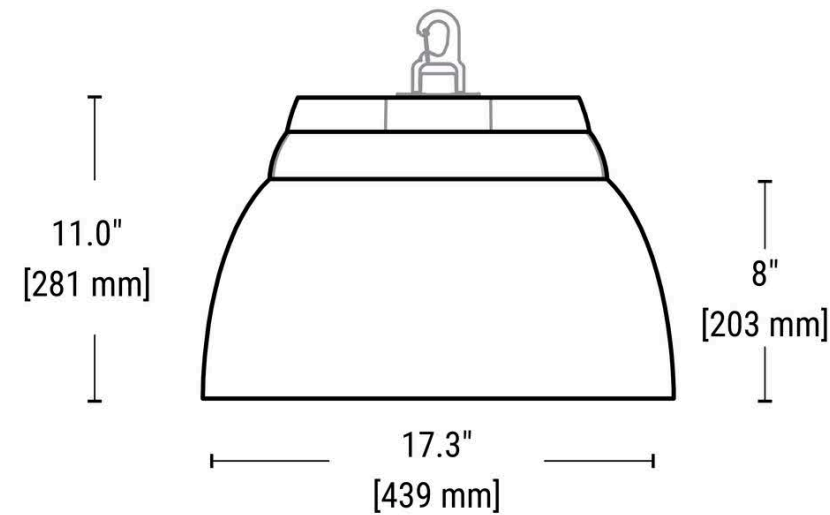

## Dimensions - Large

**PRLX-UHBS2-2436**  
(Large PrentaLux High Bay)

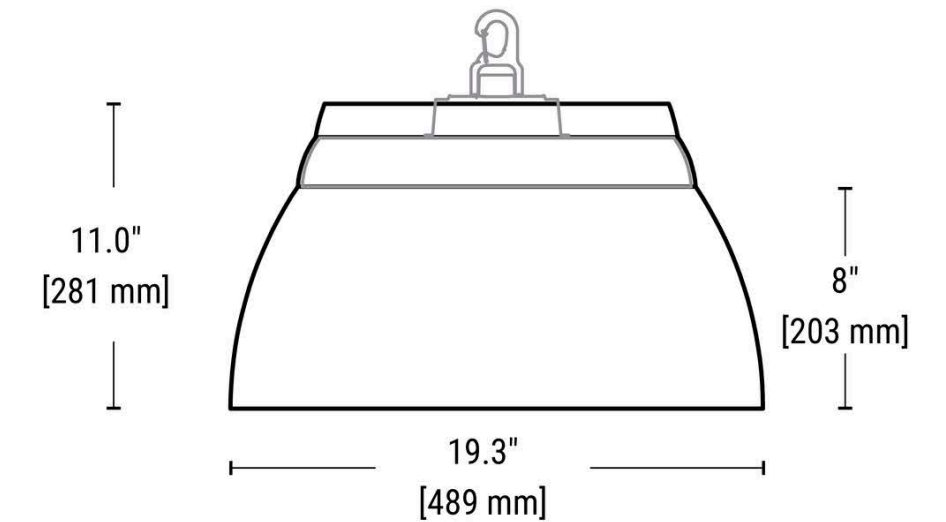

Filament only

[Table of Contents](#)

# Decorative High Bay Gen 2

## Standard Opaque Shade Colors

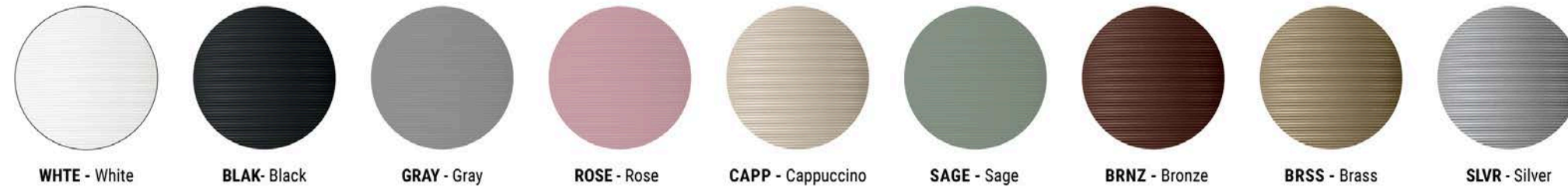

## Standard Translucent Shade Colors

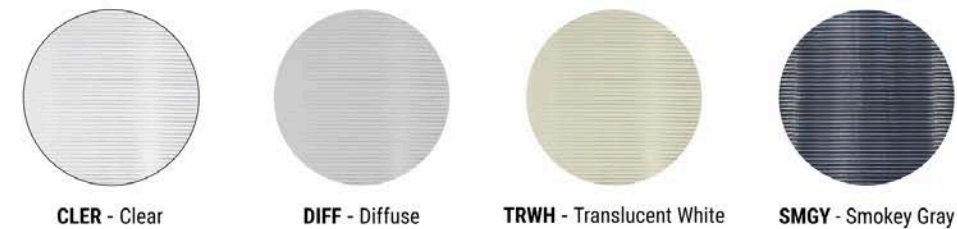

## On-Demand Translucent Shade Colors

These special color options may have extended lead times and/or additional costs. Please consult factory.



## On-Demand Opaque Shade Colors

These special color options may have extended lead times and/or additional costs. Please consult factory.



[Click here for more dimensions and extra specifications.](#)

Visit [www.signify.com/warranties](http://www.signify.com/warranties) for complete warranty information.

## Configuration Page

[High Bay Gen 2](#) . . . . .



[Table of Contents](#)

# PERFORMANCE INTEGRAL LED PENDANTS

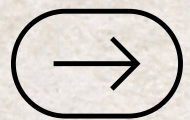

High-performance and stylish lighting solutions ideal for hospitality, office, retail, and other indoor environments.



**2000 Series**  
2001, 2002, 2004

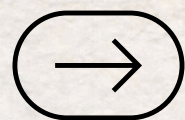

**200 Series**  
205, 206, 210, 215, 225, 235

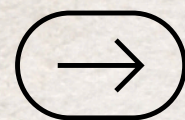

**200 Single Shade Series**  
240, 241, 242, 243

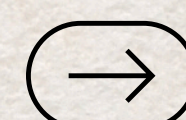

**Architecture Research Office  
Series Pendants**  
Nimbaro, Minaro, Unaro

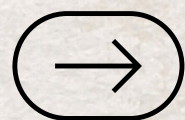

# PrentaLux

INTEGRAL LED  
PERFORMANCE PENDANTS



The PrentaLux 2000 Series blends timeless form with modern performance. And it's customizable to adapt to any space.

Available in multiple sizes and lumen packages, each pendant delivers high-fidelity light with smooth 1% dimming. Choose from a wide palette of inner/outer colors and textures, as well as stem or cable suspension.

The 2000 Series offers designers a versatile, sustainable, and statement-worthy lighting solution.

## **2000 Series**

2001, 2002, 2004

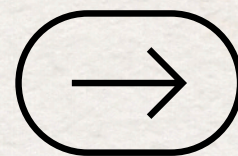

## 2001 - Tapered Drum

---



Small



Medium

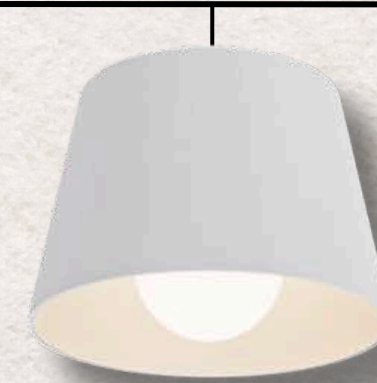

Large

## 2002 - Truncated Dome

---



Small



Medium



Large

## 2004 - Curved Bell

---



Small



Medium



Large

## 2000 Series: Applications



## 2000 Series: **Closeups**

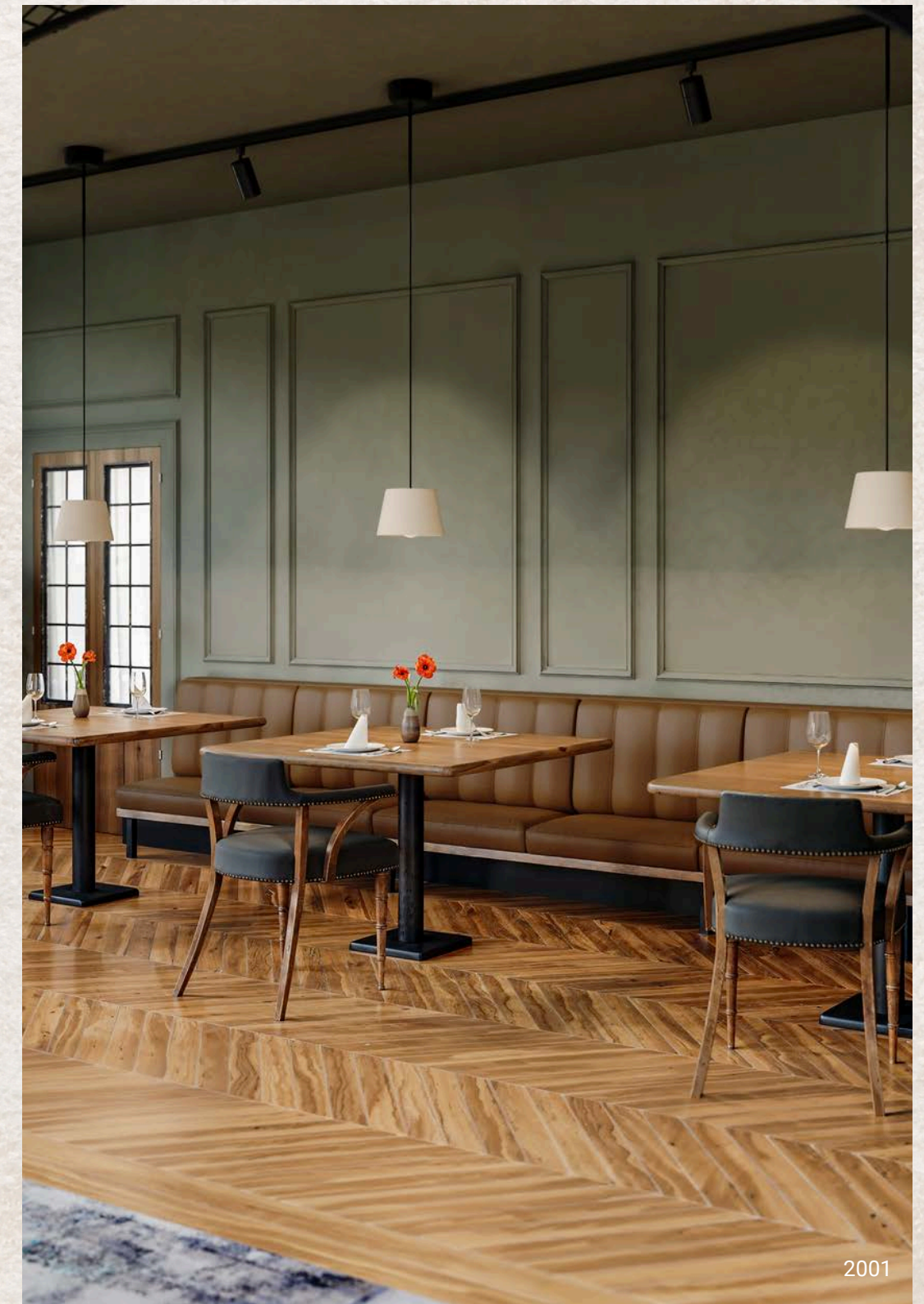



# PrentaLux 2000 Series

## Key Specifications

- Rich palette of standard and on-demand shade colors
- 3 standard shade shapes, 2001 Tapered Drum, 2002 Truncated Dome, 2004 Curved Bell
- Integral LED light engine comes in 3 sizes with up to 8 output levels per size ranging from nominal 500 lms to 13,000 lms
- Impact resistant polycarbonate with at least 75% bio-circular materials
- 90+ CRI standard with 4 CCT options (2700K, 3000K, 3500K, 4000K)
- 5-year limited warranty

## Operational & Certifications

**Compliance & Certifications:** UL-certified (Filament), UL-recognized components, RoHS, Declare Compliant, LBC Red List Approved, ISCC Certified

**Application Rating:** Suitable for damp locations

**Protection Class:** IK06

**Warranty:** 5 Year Limited

## Electrical

**Input Voltage:** 120-277V

**Frequency:** 60Hz

**Power Factor:** NR

**Dimming:** 0-10V dimming, 100-1%

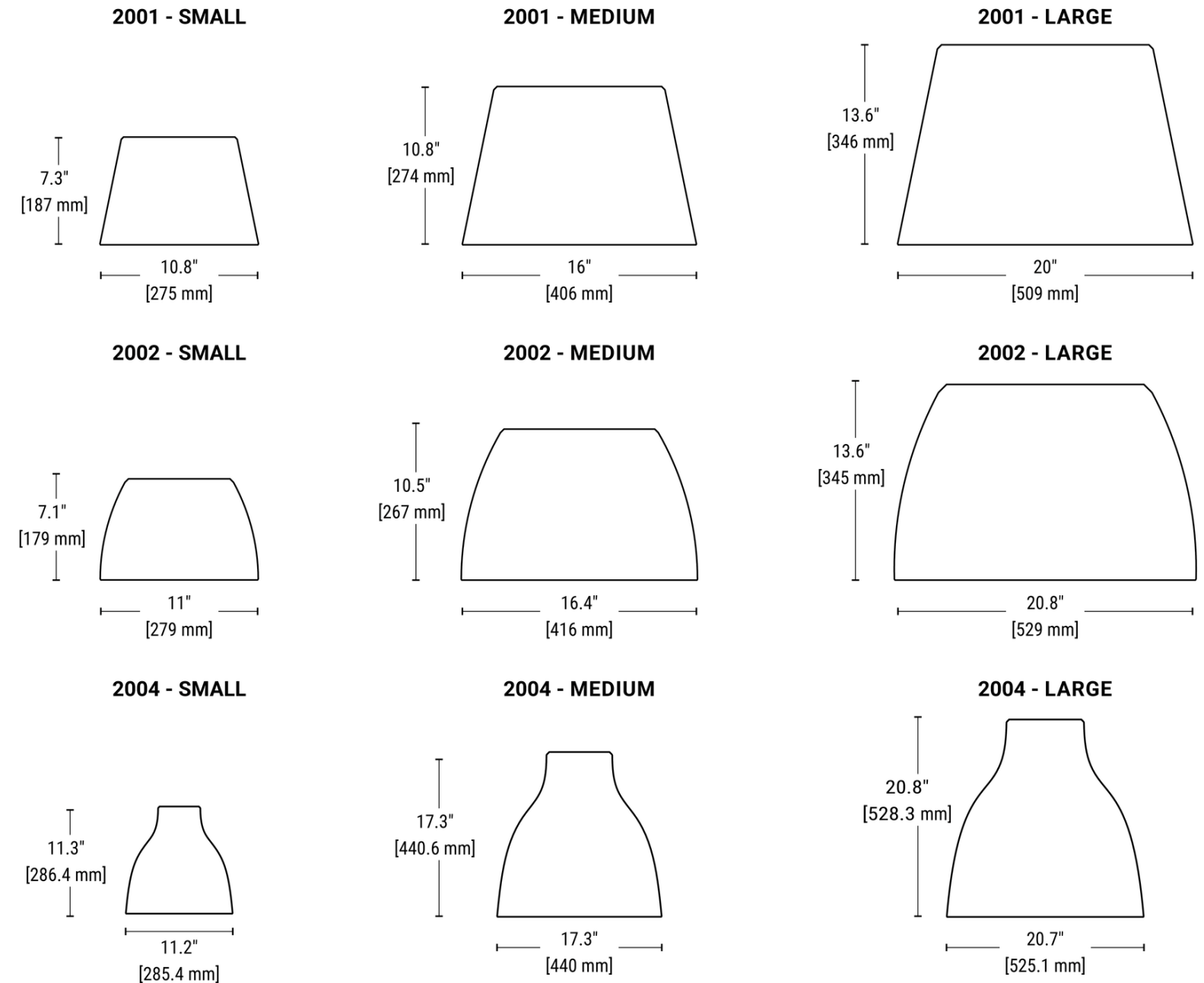

Filament only

[Table of Contents](#)

# PrentaLux 2000 Series

## Standard Outer Shade Colors



## Inner Shade Colors



## On-Demand Colors

These On-Demand color options for housing and trims may have extended lead times and/or additional costs. Please consult factory.

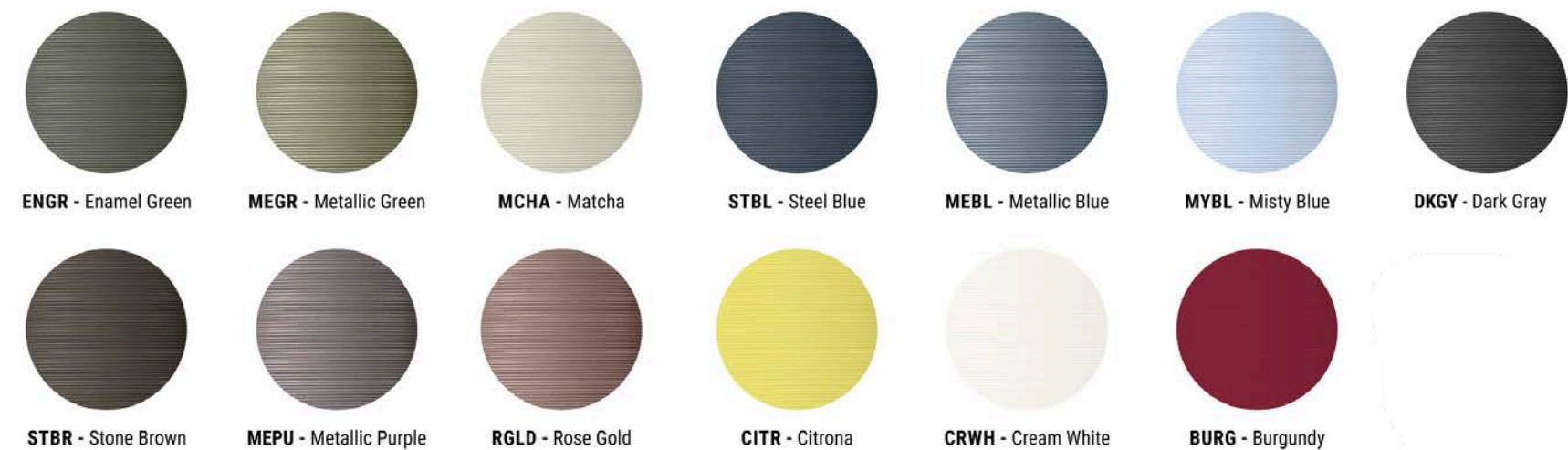

[Click here for more dimensions and extra specifications.](#)

Visit [www.signify.com/warranties](http://www.signify.com/warranties) for complete warranty information.

## Configuration Page

**2000 Series** · · · · ·

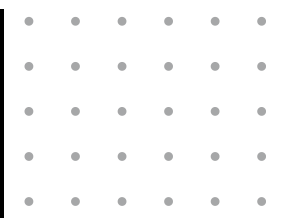

[Table of Contents](#)

**Explore our**  
2000 Series Lookbook

---



[Scan the QR](#)  
[or click here](#)



This series of integral pendants is a stunning blend of elegance and functionality. A wide array of inner and outer shade color and texture options gives designers the creative freedom to personalize luminaires to suit their aesthetic preference.

Our 200 Series pendants are crafted from a minimum of 75% recycled or mass-balanced bio-circular plastics. So, designers and engineers know they're choosing a sustainable and stylish solution.

## **200 Series Dual Shades**

205, 206, 210, 215, 225, 235

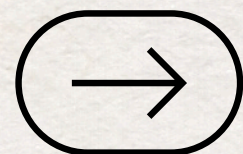

## Dual Shades



205



210



225



206



215



235

# 200 Series Dual Shades: Applications



## 200 Series Dual Shades: **Closeups**



# PrentaLux 200 Series Dual Shades

## Key Specifications

- Integral LED light engine with 8 Light Levels ranging from nominal 1000 to 9000+ lumens
- Efficacy up to 150+ lm/w
- 90+ CRI standard with 4 CCT options (2700K, 3000K, 3500K, 4000K)
- Rich pallet of shade colors and textures - Standard & On-Demand
- Impact resistant polycarbonate with at least 75% bio-circular materials
- Declare compliant, LBC Red List approved

## Operational & Certifications

**Compliance & Certifications:** UL-certified (Filament), UL-recognized components, RoHS, Declare Compliant, LBC Red List Approved, ISCC Certified

**Application Rating:** Suited for 25° ambient. Dry location only.

**Protection Class:** IK02

**Warranty:** 5 Year Limited

## Electrical

**Input Voltage:** 120-277V

**Frequency:** 60Hz

**Power Factor:** NR

**Dimming:** 0-10V dimming, 100-1%

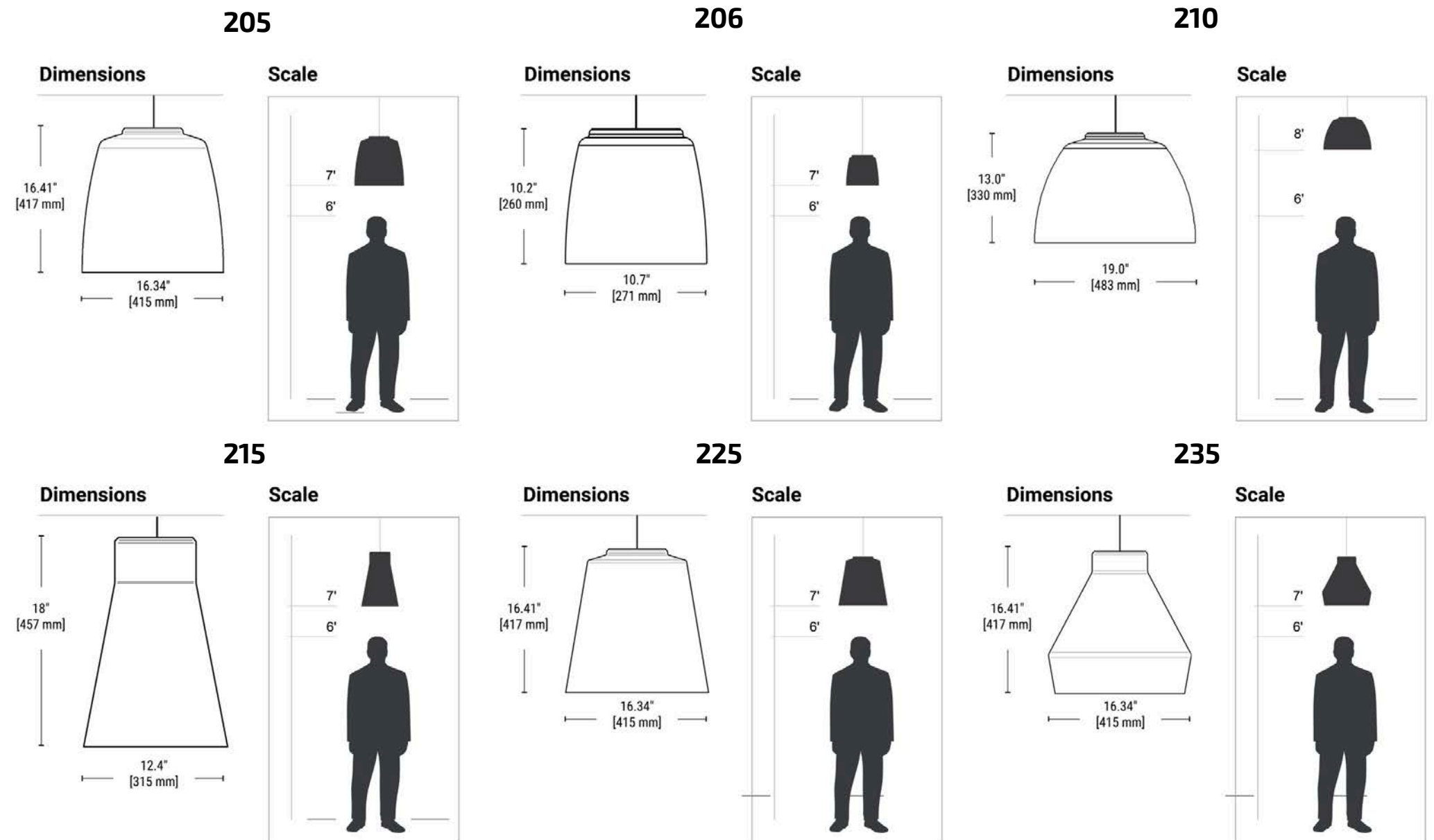

Filament only

[Table of Contents](#)

# PrentaLux 200 Series Dual Shades

## Standard Opaque Outer Shade Colors



## Standard Inner Shade Colors



## On-Demand Colors

These On-Demand color options for inner and outer shade may have extended lead times and/or additional costs. Please consult factory.

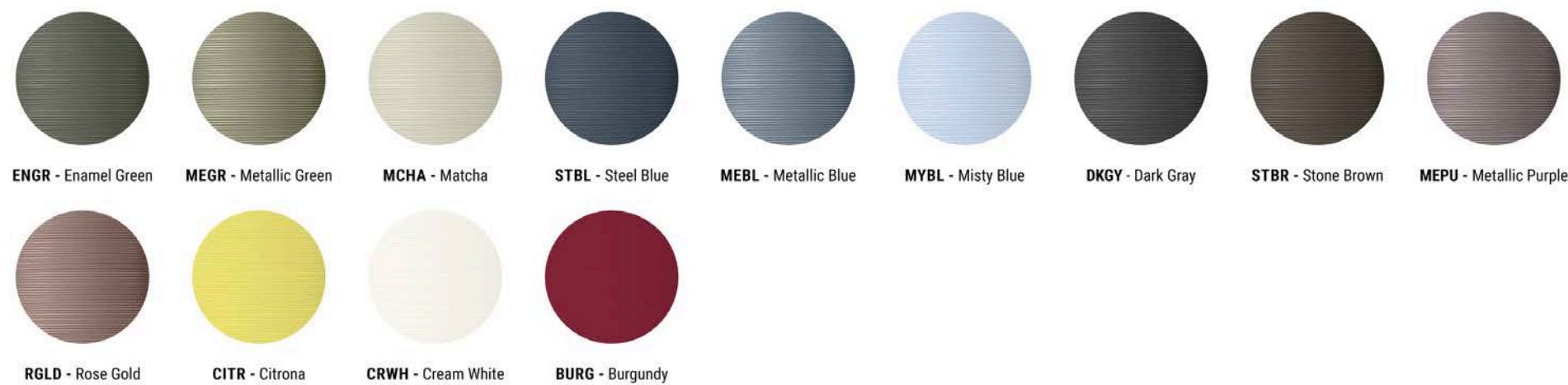

[Click here for more dimensions and extra specifications.](#)

Visit [www.signify.com/warranties](http://www.signify.com/warranties) for complete warranty information.

## Outer Shade Textures



## Inner Shade Textures



## Configuration Page

[200 Series Dual Shades](#) . . . . .

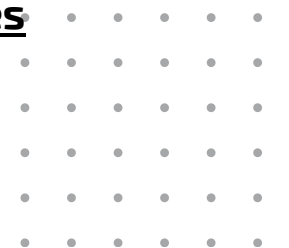

[Table of Contents](#)



This series of integral pendants is designed with single shade construction, providing a lower cost performance decorative pendant option. Even with a single shade, create unique looks with many color and texture options for opaque and translucent shades.

Our 200 Single Shade Series pendants are crafted from a minimum of 75% recycled or mass-balanced bio-circular plastics. Experience stylish and sustainable pendants thanks to PrentaLux advanced 3D printing technology.

## **200 Single Shade Series**

240, 241, 242, 243

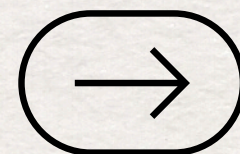

## 200 Single Shade Series



240



242



241



243

## 200 Single Shade Series: Applications



## 200 Single Shade Series: **Closeups**





# PrentaLux 200 Single Shade Series

## Key Specifications

- Integral LED light engine with 8 Light Levels ranging from nominal 1000 to 8000+ lumens
- Efficacy up to 150+ lm/w
- 90+ CRI standard with 4 CCT options (2700K, 3000K, 3500K, 4000K)
- Rich pallet of shade colors and textures - Standard & On-Demand
- Impact resistant polycarbonate with at least 75% bio-circular materials
- Declare compliant, LBC Red List approved

## Operational & Certifications

**Compliance & Certifications:** RoHS, UL-certified (Filament), UL-recognized components, RoHS, Declare Compliant, LBC Red List Approved, ISCC Certified

**Application Rating:** Suitable for damp locations.

**Protection Class:** IK02 impact rated

**Warranty:** 5 Year Limited

## Electrical

**Input Voltage:** 120-277V

**Frequency:** 60Hz

**Power Factor:** NR

**Dimming:** 0-10V dimming, 100-1%

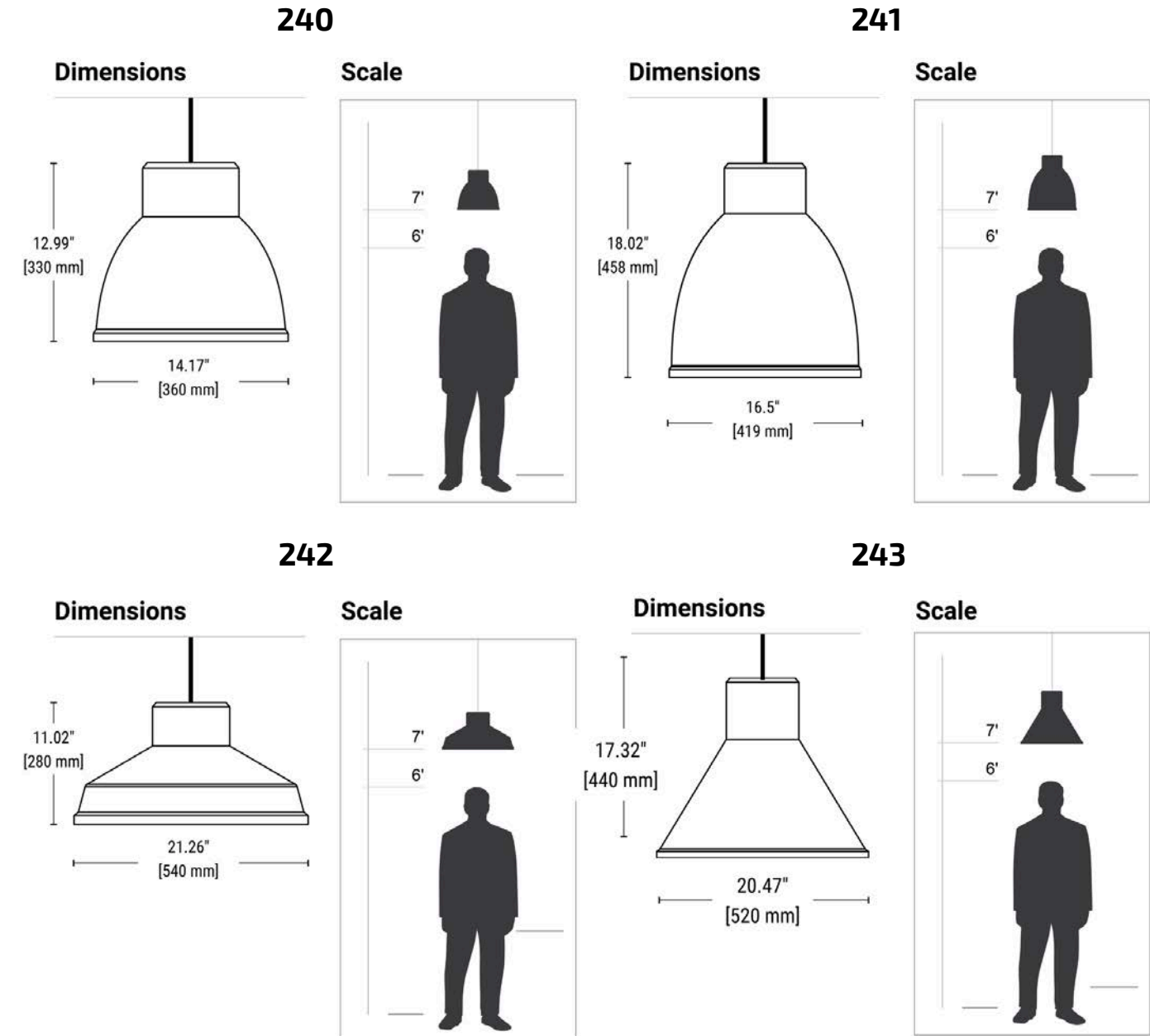

Filament only

[Table of Contents](#)

# PrentaLux 200 Single Shade Series

## Standard Opaque Shade Colors



## On-Demand Transparent Shade Colors

These On-Demand color options may have extended lead times and/or additional costs. Please consult factory.



## Standard Transparent/Translucent Shade Colors



## On-Demand Opaque Shade Colors

These On-Demand color options may have extended lead times and/or additional costs. Please consult factory.



## Shade Textures

Additional textures available. Please consult factory.



Layered Fine (LF)

Natural Lines (NL)

Pinstripe (PNS)

Note:  
Translucent Shade colors only available with Pinstripe Texture

## Configuration Page

### 200 Single Shade Series

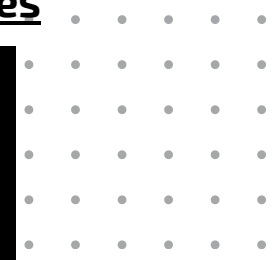

[Click here for more dimensions and extra specifications.](#)

Visit [www.signify.com/warranties](http://www.signify.com/warranties) for complete warranty information.

[Table of Contents](#)

**Explore our**  
200 Series Lookbook

---



[Scan the QR](#)  
[or click here](#)



## Architecture Research Office Series Pendants

Nimbaro, Minaro, Unaro

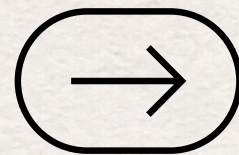

The PrentaLux Architecture Research Office Series Pendants are a celebration of form, translucency, and texture. Designed in collaboration with award-winning Architecture Research Office (ARO), these three high-performance decorative luminaires, each with a unique shape, were inspired by natural metamorphic forms.

Additive-manufactured with a sustainable use of resources in mind, these striking pendants are available in three sizes and a variety of textures.

They can be used individually or grouped in complementary arrangements – perfect for both large public spaces and intimate settings. For those who love design-forward, sculptural lighting.

**Nimbaro**

---



**Small**



**Medium**



**Large**

**Minaro**

---



**Small**



**Medium**

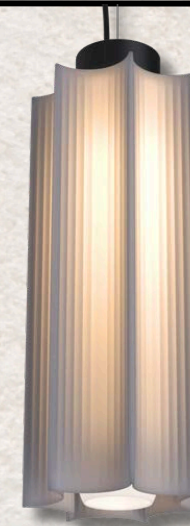

**Large**

**Unaro**

---



**Small**



**Medium**



**Large**

## Architecture Research Office Series Pendants: **Applications**

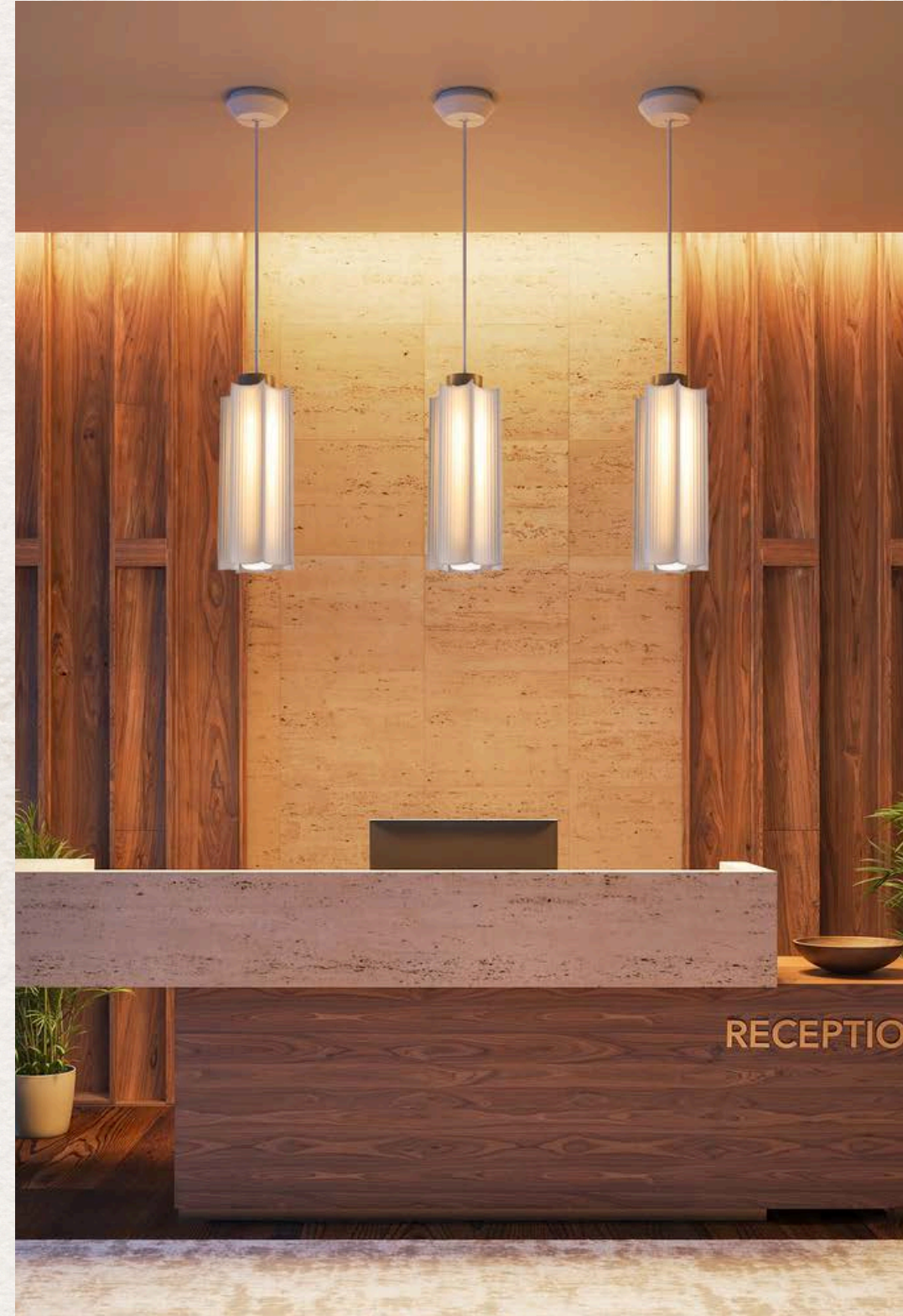

## Architecture Research Office Series Pendants: **Closeups**





# PrentaLux Architecture Research Office Series Pendants

## Key Specifications

- PrentaLux Architecture Research Office Series Pendants utilize Cooper Lighting Solutions proprietary 3D printing process
- Integral LED light engine comes in 3 sizes with up to 8 output levels per size ranging from nominal 150 lms to 2700+ lms
- 90+ CRI standard with 4 CCT options (2700K, 3000K, 3500K, 4000K)

## Operational & Certifications

**Compliance & Certifications:** UL-certified (Filament), UL-recognized components, RoHS, BAA Compliant, ISCC Certified  
**Application Rating:** Suitable for damp locations  
**Warranty:** 5 Year Limited

## Electrical

**Input Voltage:** 120-277V  
**Frequency:** 60Hz  
**Power Factor:** NR  
**Dimming:** 0-10V dimming, 100-1%

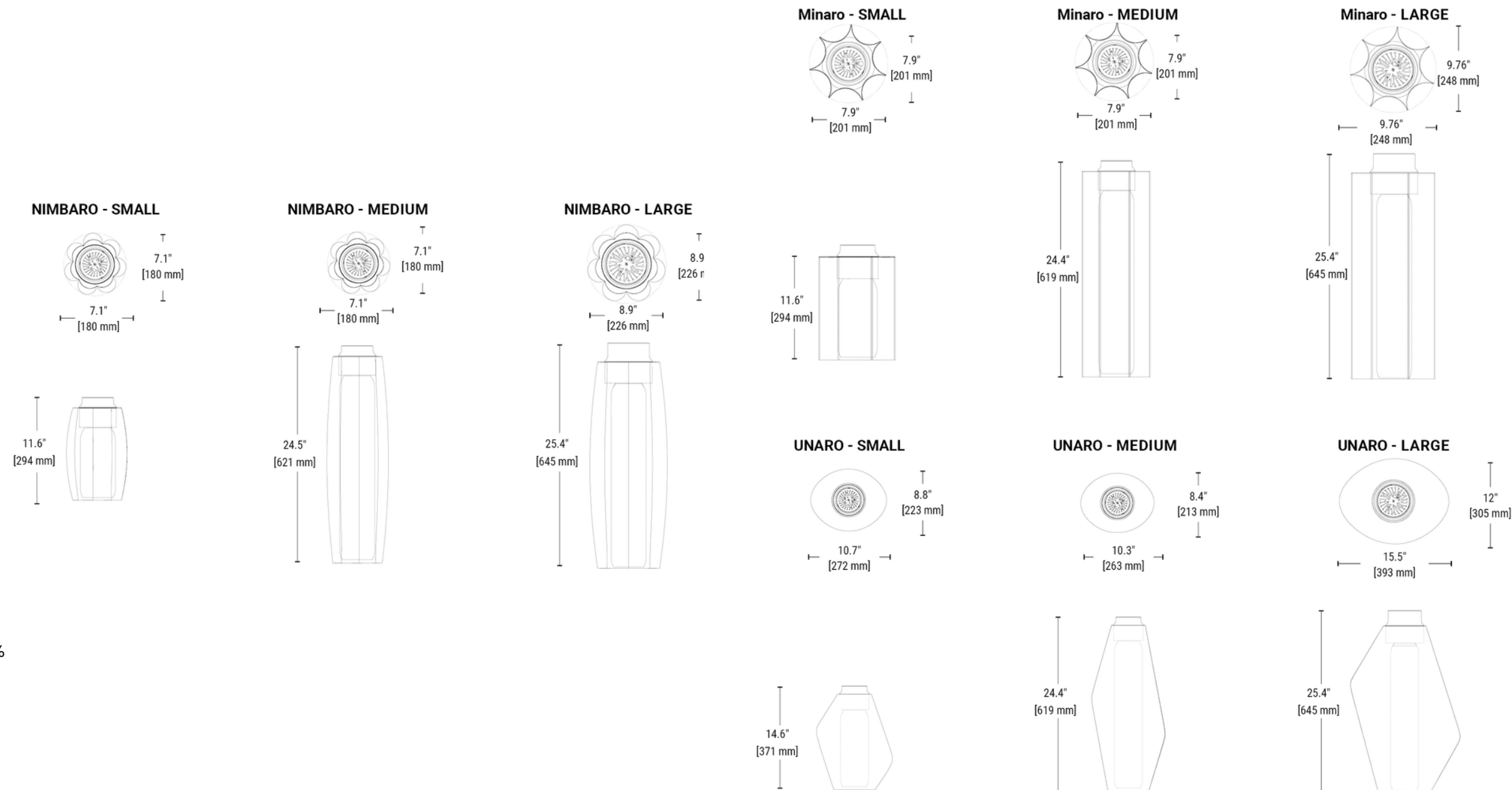

Filament only



# PrentaLux Architecture Research Office Series Pendants

## Shade Color



TRWH - Translucent White

## Standard Finial and Canopy Colors



WHTE - White



BLAK - Black



GRAY - Gray



ROSE - Rose



CAPP - Cappuccino



SAGE - Sage



BRNZ - Bronze



BRSS - Brass



SLVR - Silver

## On-Demand Colors

These additional color offerings for finial and canopy may have extended lead times and/or additional costs.

Please consult factory.



ENGR - Enamel Green



MEGR - Metallic Green



MCHA - Matcha



STBL - Steel Blue

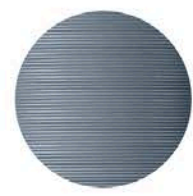

MEBL - Metallic Blue



MYBL - Misty Blue



DKGY - Dark Gray



STBR - Stone Brown



MEPU - Metallic Purple



RGLD - Rose Gold

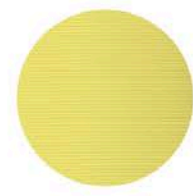

CITR - Citrona

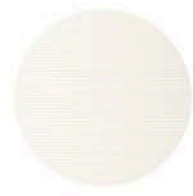

CRWH - Cream White

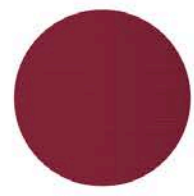

BURG - Burgundy

## Shade textures - Nimbaro

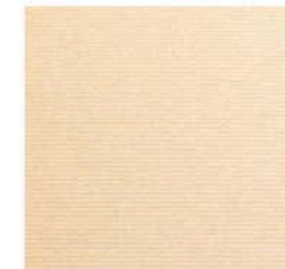

LF - Layered Fine

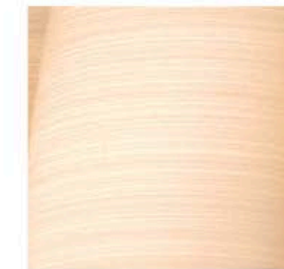

NL - Natural Lines



NR - Natural Ribs



WO - Woven Oval

## Shade textures - Minaro



NL - Natural Lines

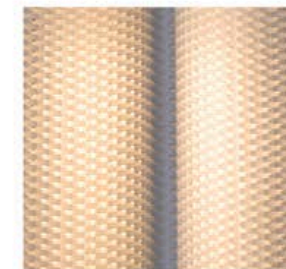

OW - Open Weave



PS - Pinstripe

## Shade textures - Unaro



NL - Natural Lines

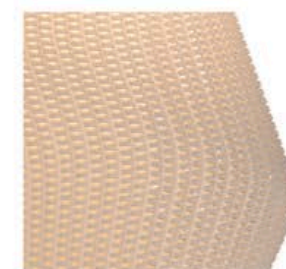

OW - Open Weave



PS - Pinstripe

[Click here for more dimensions and extra specifications.](#)

Visit [www.signify.com/warranties](http://www.signify.com/warranties) for complete warranty information.

[Table of Contents](#)

# DECORATIVE LAMP-BASED PENDANTS

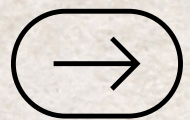

Small, medium and large modern decorative pendants designed with circularity in mind, for office, commercial, retail and other indoor spaces.



### 300 Series

301, 303, 305, 307, 309, 309WC, 311, 311WC, 313

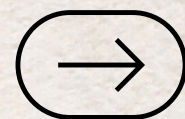

### 400 Series

401, 403, 405, 407, 409, 411, 413, 415, 417

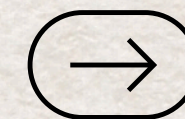

# PrentaLux

DECORATIVE LAMP-BASED  
PENDANTS



This series of A19 LED lamp-based decorative pendants offer sustainable design with modern form.

3D printed parts are produced with at least 75% mass balanced bio-circular materials or - in the case of our Water Cooler fixture - at least 55% recycled polycarbonate from post-consumer water jugs.

Get creative freedom at your fingertips with a variety of colors for top finials and opaque or translucent shades. And select the mounting canopy best suited to your space, with disk and conical shapes available.

## 300 Series

301, 303, 305, 307, 309, 311, 313

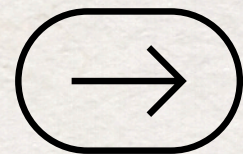

**300 Series**

---



**301**



**303**



**305**



**307**



**309**



**309**  
Water Cooler



**311**



**311**  
Water Cooler



**313**

## 300 Series: Applications

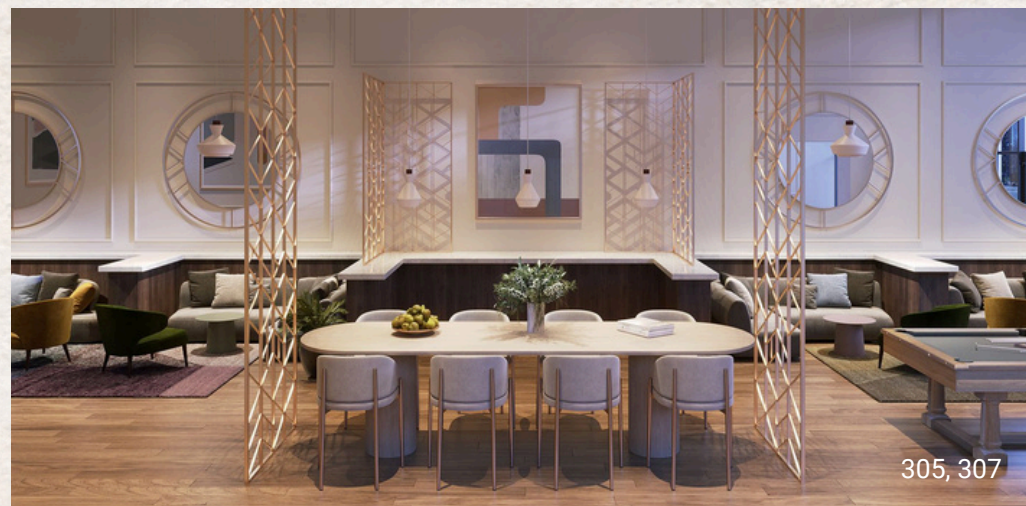
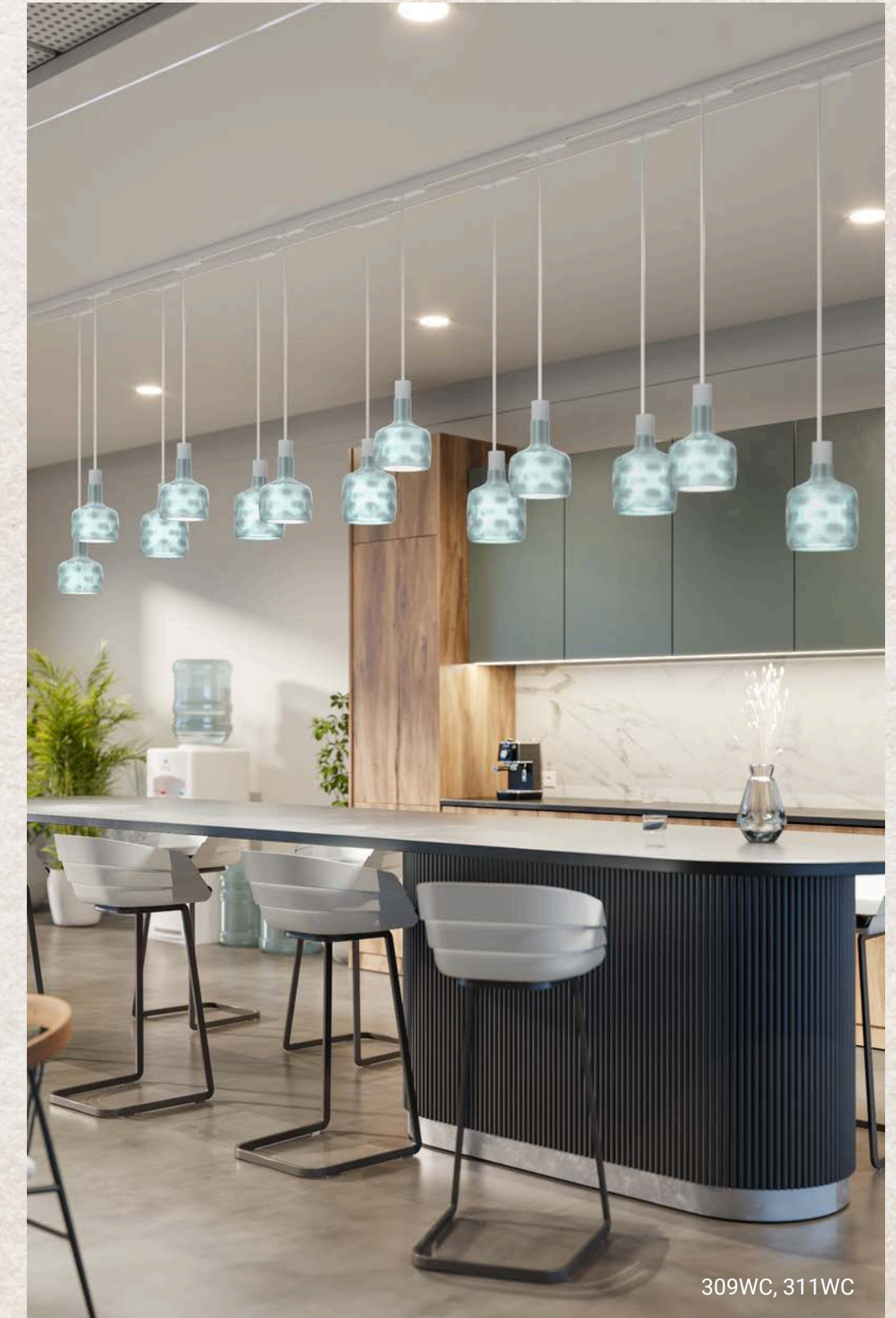

## 300 Series: Closeups





# PrentaLux 300 Series

Excluding water cooler pendants

## Key Specifications

- Modern forms available in 8 standard opaque colors and 4 standard transparent/translucent colors
- A19 Lamp based, E26 socket: Frosted lamp, Filament lamp, or no lamp (lamp is provided by others up to 50W), options
- 3D printed mounting canopy available in disk or conical shape
- Black or white power cord
- BAA compliant. RoHS compliant
- Declare compliant, LBC Red List Free

## Operational & Certifications

**Compliance & Certifications:** UL-certified (Filament), Declare, LBC Red List Free, ISCC Certified, RoHS Compliant

**Application Rating:** Suited for 25°C ambient. Dry location only.

**Protection Class:** IK02

**Warranty:** 5 Year Limited

## Electrical

**Input Voltage:** 120V

**Frequency:** 60 Hz

**Power Factor:** 0.9

**Dimming:** Dimming determined by lamp selection



Filament only.



Declare.



LIVING BUILDING CHALLENGE™

301

Dimensions

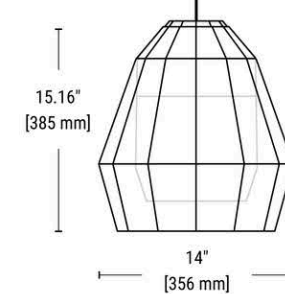

Scale

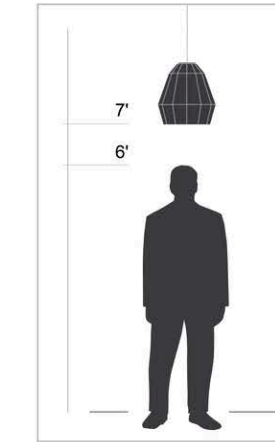

303

Dimensions

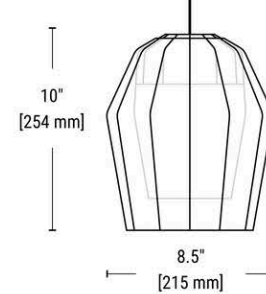

Scale

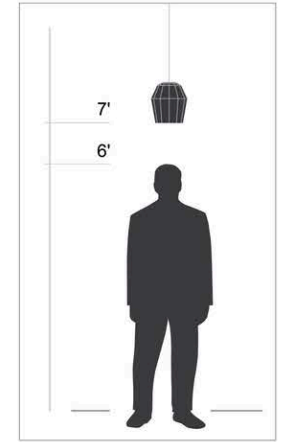

305

Dimensions

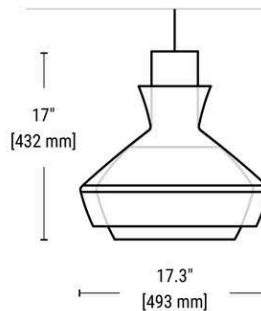

Scale

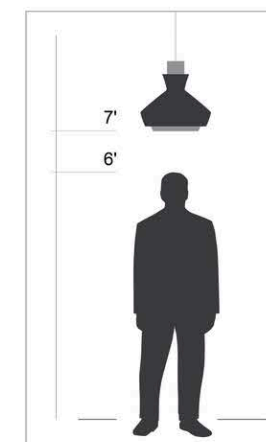

307

Dimensions

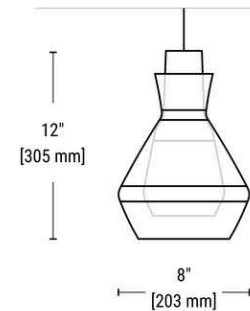

Scale

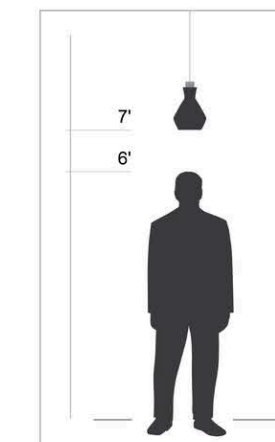

309

Dimensions

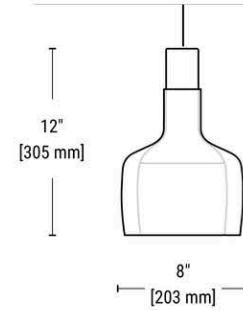

Scale

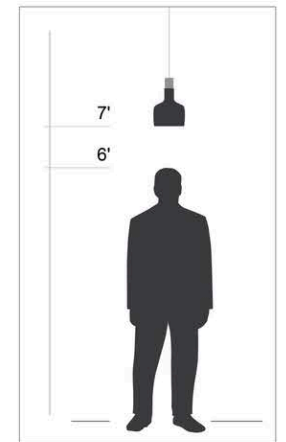

311

Dimensions

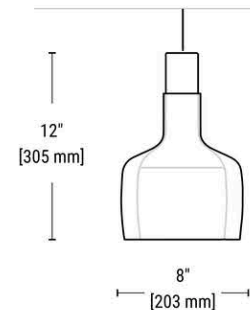

Scale

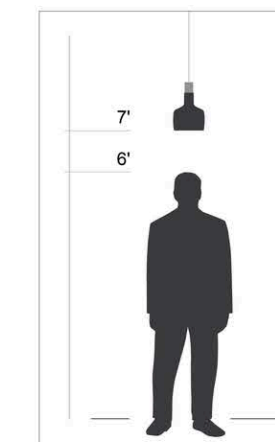

313

Dimensions

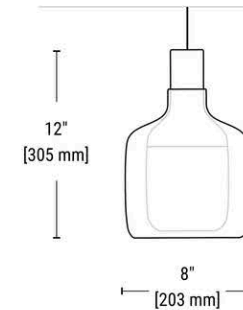

Scale

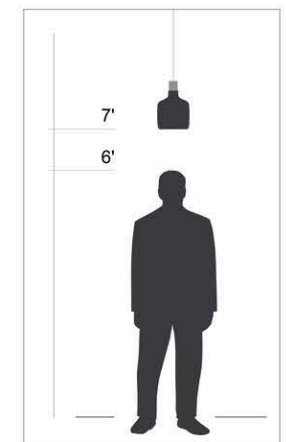

[Table of Contents](#)

# PrentaLux 300 Series - Water Cooler

## Key Specifications

- Outer shade is designed to create an artisanal glass like texture designed to complement real glass like effects
- A19 Lamp based, E26 socket: Frosted lamp, Filament lamp, or no lamp (lamp is provided by others up to 50W), options
- 3D printed White mounting canopy available in disk or conical shape
- White power cord
- BAA compliant. RoHS compliant
- Declare compliant, LBC Red List Free
- 5 Year Warranty

## Operational & Certifications

**Compliance & Certifications:** UL-certified (Filament), RoHS Compliant  
**Application Rating:** Suited for 25°C ambient. Dry location only.  
**Protection Class:** IK02  
**Warranty:** 5 Year Limited

## Electrical

**Input Voltage:** 120V  
**Frequency:** 60 Hz  
**Power Factor:** 0.7-0.8  
**Dimming:** Dimmable



## 309 Water Cooler

### Dimensions

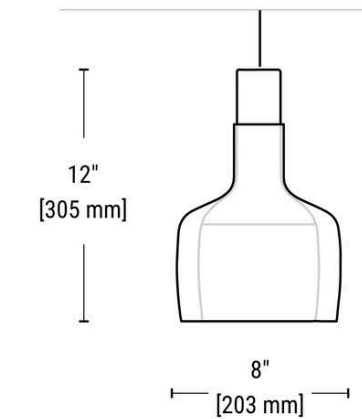

### Scale

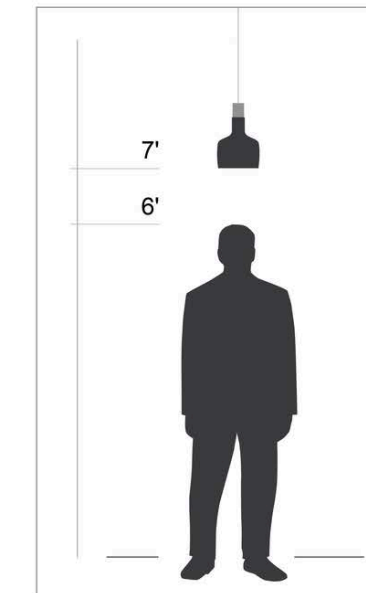

## 311 Water Cooler

### Dimensions

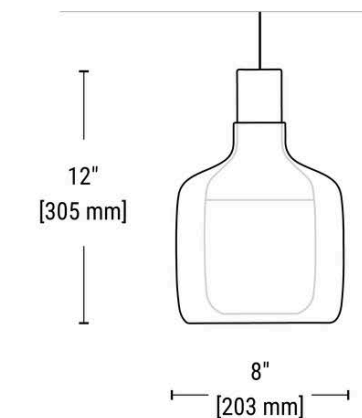

### Scale

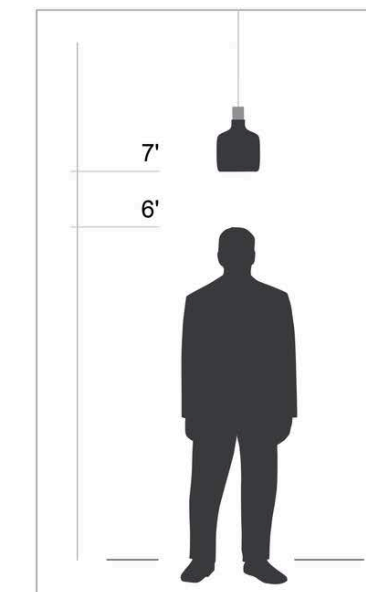

# PrentaLux 300 Series

## Standard Opaque Shade & Top Finial Colors



## Standard Transparent/Translucent Shade Colors

Not available for top finial.



## On-Demand Opaque Shade & Top Finial Colors

These special color options may have extended lead times and/or additional costs. Please consult factory.



## On-Demand Transparent Shade Colors

These On-Demand color options may have extended lead times and/or additional costs. Please consult factory. Not available for top finial.



## Finial Color Recommendations



## Configuration Page

**300 Series**



**309-WC**



**311-WC**



[Click here for more dimensions and extra specifications.](#)

Visit [www.signify.com/warranties](http://www.signify.com/warranties) for complete warranty information.

[Table of Contents](#)



This series of A19 LED lamp-based decorative pendants offer sustainable design with modern form.

3D printed parts are produced with at least 75% mass balanced bio-circular materials.

Get creative freedom at your fingertips with a variety of colors for top finials and opaque or translucent shades. And select the mounting canopy best suited to your space, with disk and conical shapes available.

## 400 Series

401, 403, 405, 407, 409, 411, 413, 415, 417

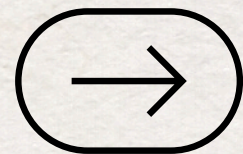

## 400 Series



401



403



405



407



409



411



413



415



417

## 400 Series: Applications

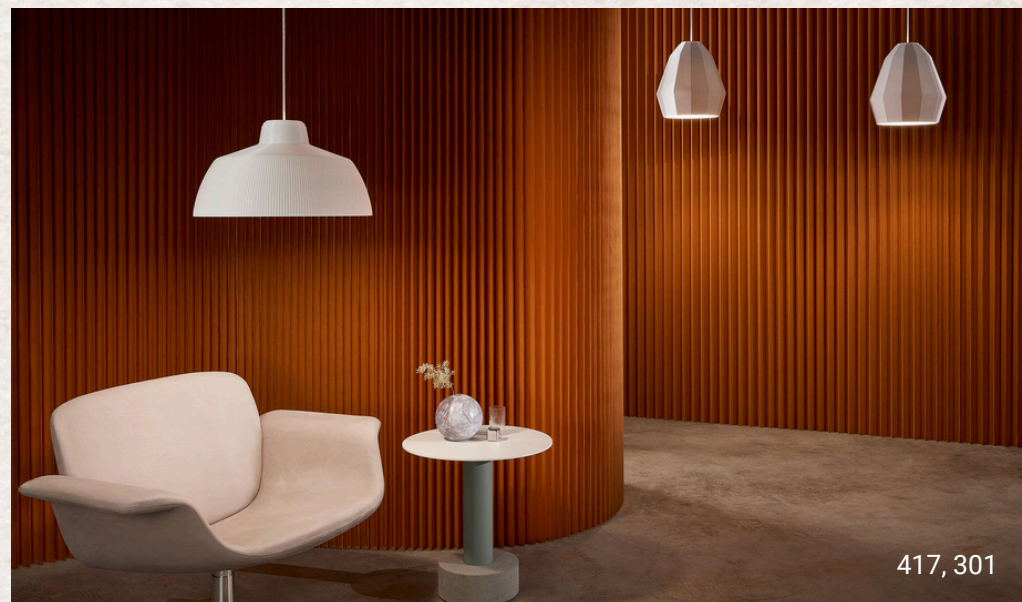

## 400 Series: Closeups





# PrentaLux 400 Series

## Key Specifications

- Modern form available in 8 standard opaque colors and 4 standard transparent/translucent colors
- A19 Lamp based, E26 socket: Frosted lamp, Filament lamp, or no lamp (lamp is provided by others), options
- 3D printed mounting canopy available in disk or conical shape
- Black or white power cord
- BAA compliant. RoHS compliant
- Declare compliant, LBC Red List Free
- 5 Year Warranty

## Operational & Certifications

**Compliance & Certifications:** UL-certified (Filament), Declare, LBC Red List Free, ISCC Certified, RoHS Compliant

**Application Rating:** Suited for 25°C ambient. Dry location only.

**Protection Class:** IK02

**Warranty:** 5 Year Limited



Filament only



LIVING BUILDING CHALLENGE™

## Electrical

**Input Voltage:** 120V

**Frequency:** 60 Hz

**Power Factor:** 0.9

**Dimming:** Dimming determined by lamp selection

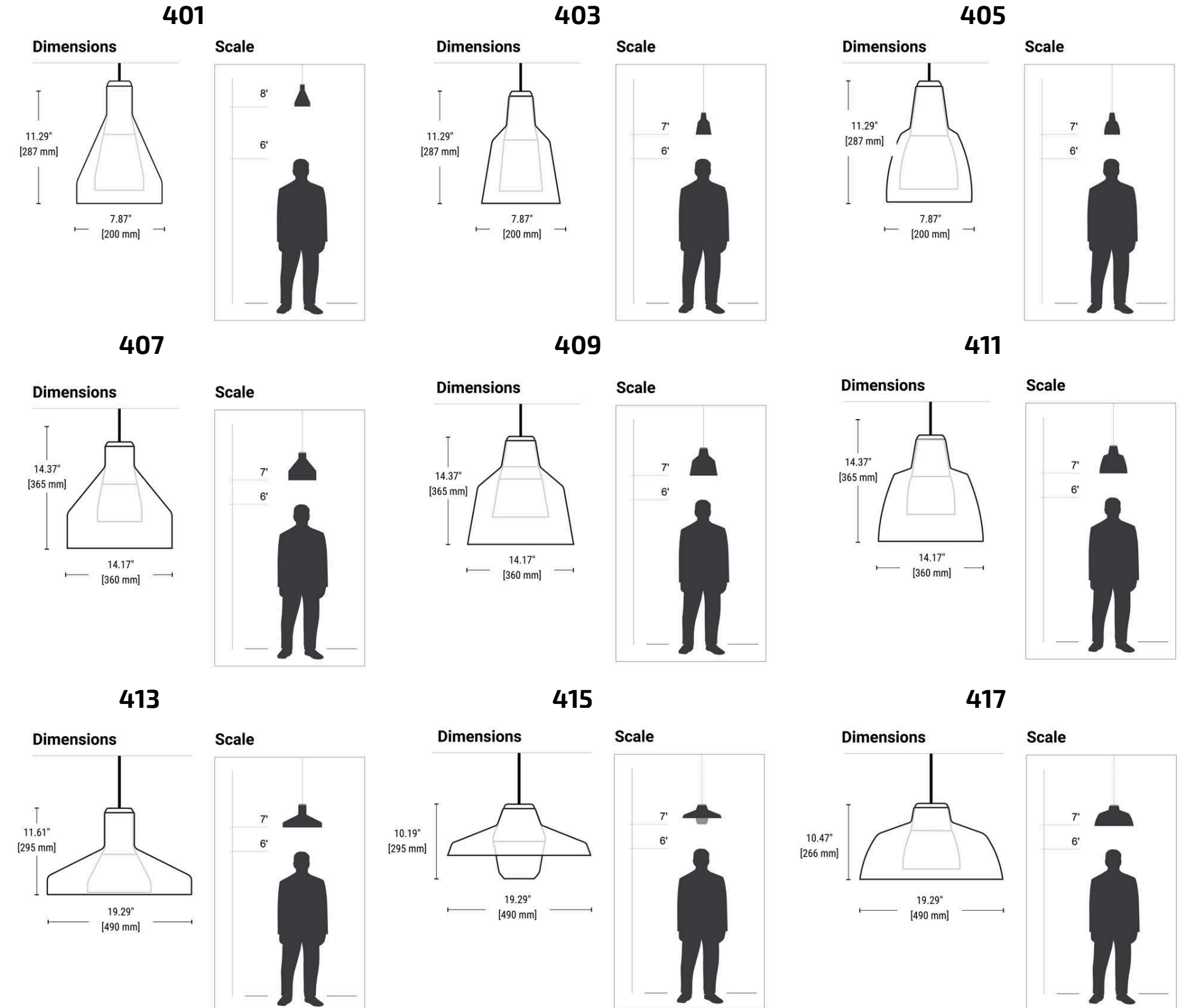

[Table of Contents](#)

# PrentaLux 400 Series

## Standard Opaque Shade & Top Finial Colors

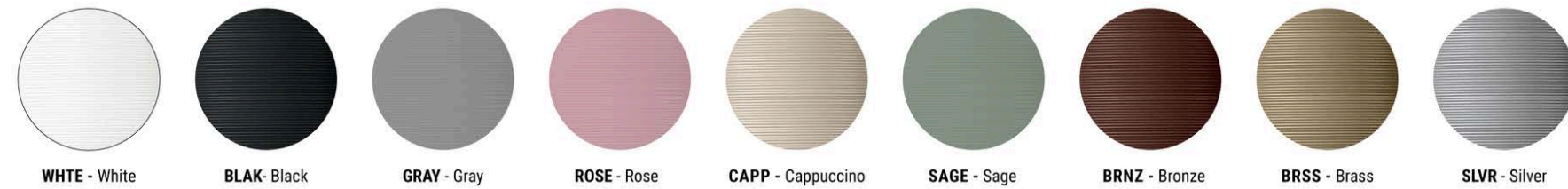

## Standard Transparent/Translucent Shade Colors

Not available for top finial.



## On-Demand Opaque Shade & Top Finial Colors

These special color options may have extended lead times and/or additional costs. Please consult factory.



## On-Demand Transparent Shade Colors

These On-Demand color options may have extended lead times and/or additional costs. Please consult factory. Not available for top finial.



## Finial Color Recommendations



**TFIN** - Top Finial Color Same as Outer Shade Color



**TFWTE** - White (if CLER, DIFF, or TRWH Outer Shade Color option chosen, White top finial is recommended)



**TFBLAK** - Black (if SMGY Outer Shade Color option chosen, Black top finial is recommended)

## Configuration Page

**400 Series** . . . . .



**[Click here for more dimensions and extra specifications.](#)**

Visit [www.signify.com/warranties](http://www.signify.com/warranties) for complete warranty information.

[Table of Contents](#)

# TAILORED SOLUTIONS

Delivered fast. At scale.

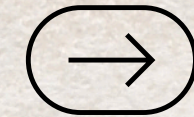

At Prentalux, we understand that not every project fits a standard solution. That's why we offer tailored solutions purpose-built to solve specific challenges, without compromising speed, quality, or scalability. Using our advanced 3D printing process and a growing library of modular luminaire platforms, we can adapt, prototype, and deliver unique solutions faster than traditional manufacturing allows. These opportunities are available for orders of qualifying volume.

# Real-world impact

## 1. Chubb



A specifier sought a distinct look and integrated controls.

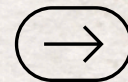

## 2. AutoStore



Faced with tight timelines and a delayed supplier, the client needed 200+ luminaires ready before office opening.

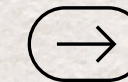

## 3. Tuscan Village



Inspired by AutoStore's results, this client required the same design in a more compact form due to ceiling constraints.

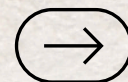

## 4. Pickleball 603



The client, a premier pickleball club, desired lighting specified for every area of the high-end club.

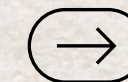



# PrentaLux | Chubb

The specifier wanted a luminaire that differed significantly from the originally approved design - both aesthetically and functionally. Instead of pushing back, we engaged directly in a “whiteboard session” to explore ideas collaboratively. Beyond aesthetics, Chubb also required **integrated controls** not supported by the standard product. The result? **718 customized luminaires** delivered for a new building - on time, at scale, and exactly to spec.

# PrentaLux | Chubb

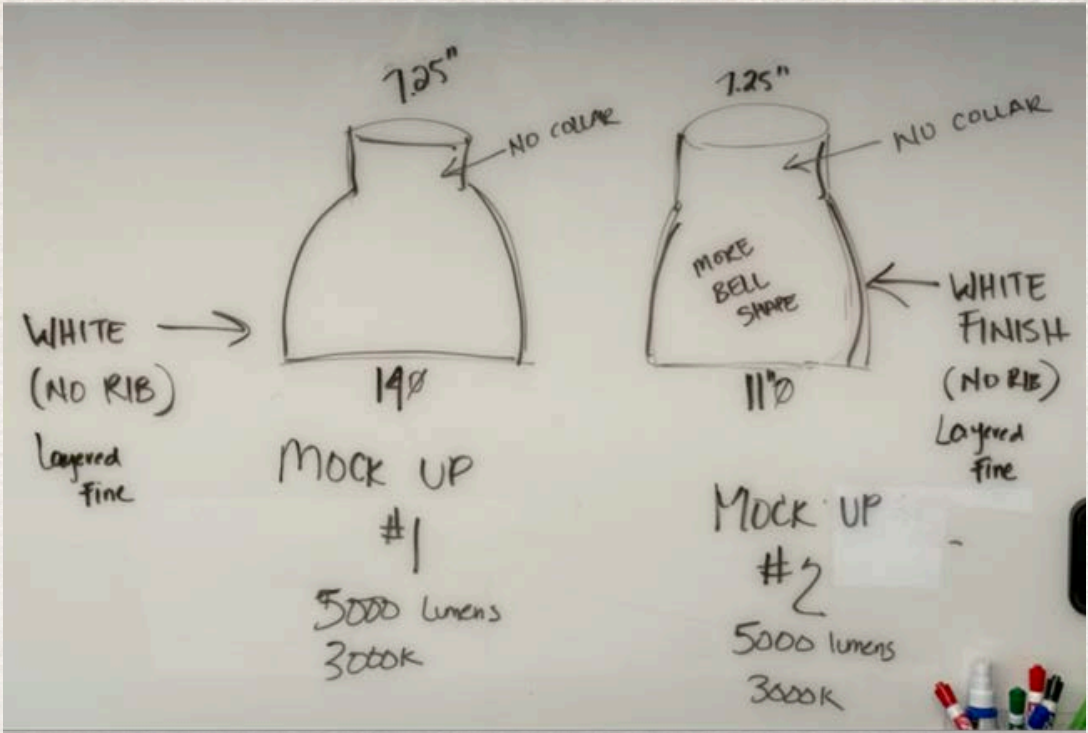
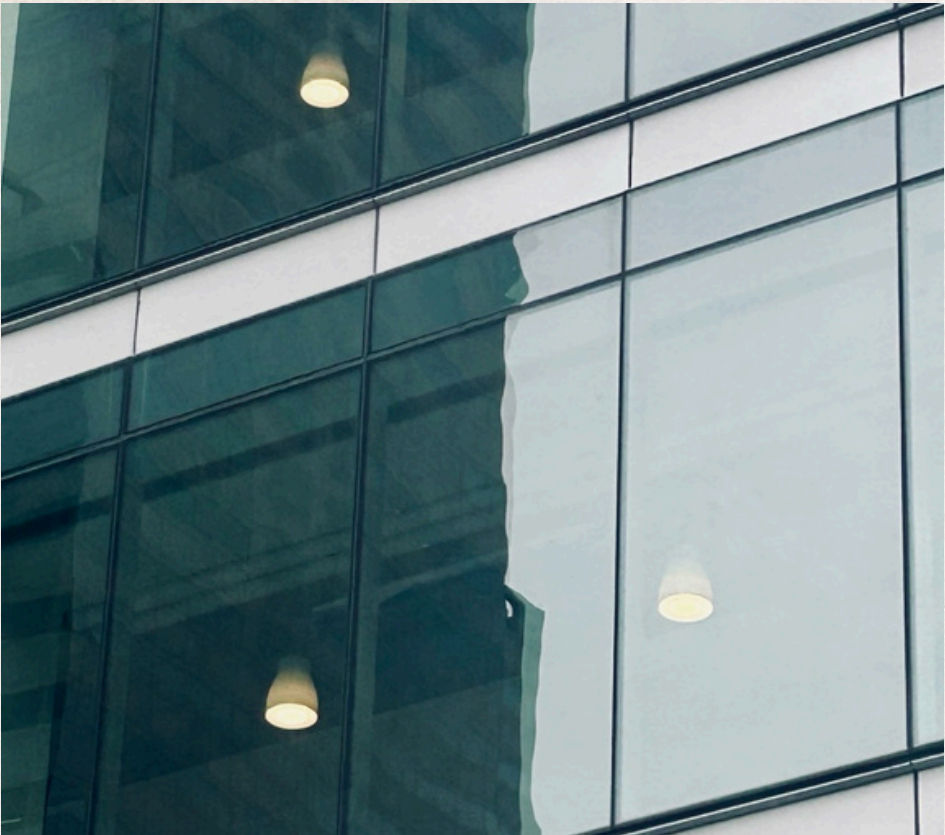



# PrentaLux | AutoStore

When the original lighting supplier failed to meet project deadlines, AutoStore faced a critical delay in opening their office. Within days, we presented a tailored concept rendering, followed by physical samples for quick approval. Working from our existing luminaire platform, we adjusted the design to their exact specifications and produced over 200 units - fully printed, assembled, and delivered within two months. Today, these luminaires have joined our standard portfolio, as the 210 performance decorative pendant.

# PrentaLux | AutoStore





# PrentaLux | Tuscan Village

After seeing the AutoStore solution, the Tuscan Village team wanted a similar design but faced reduced ceiling heights due to HVAC constraints, making the original luminaire unfit. To avoid compromising performance or design, **a shorter, compact version** was quickly re-engineered **using modular 3D-printed architecture**, allowing the client to maintain their vision and construction schedule without starting over. This luminaire has now joined our standard portfolio as the 206 performance decorative pendant.

# PrentaLux | Tuscan Village



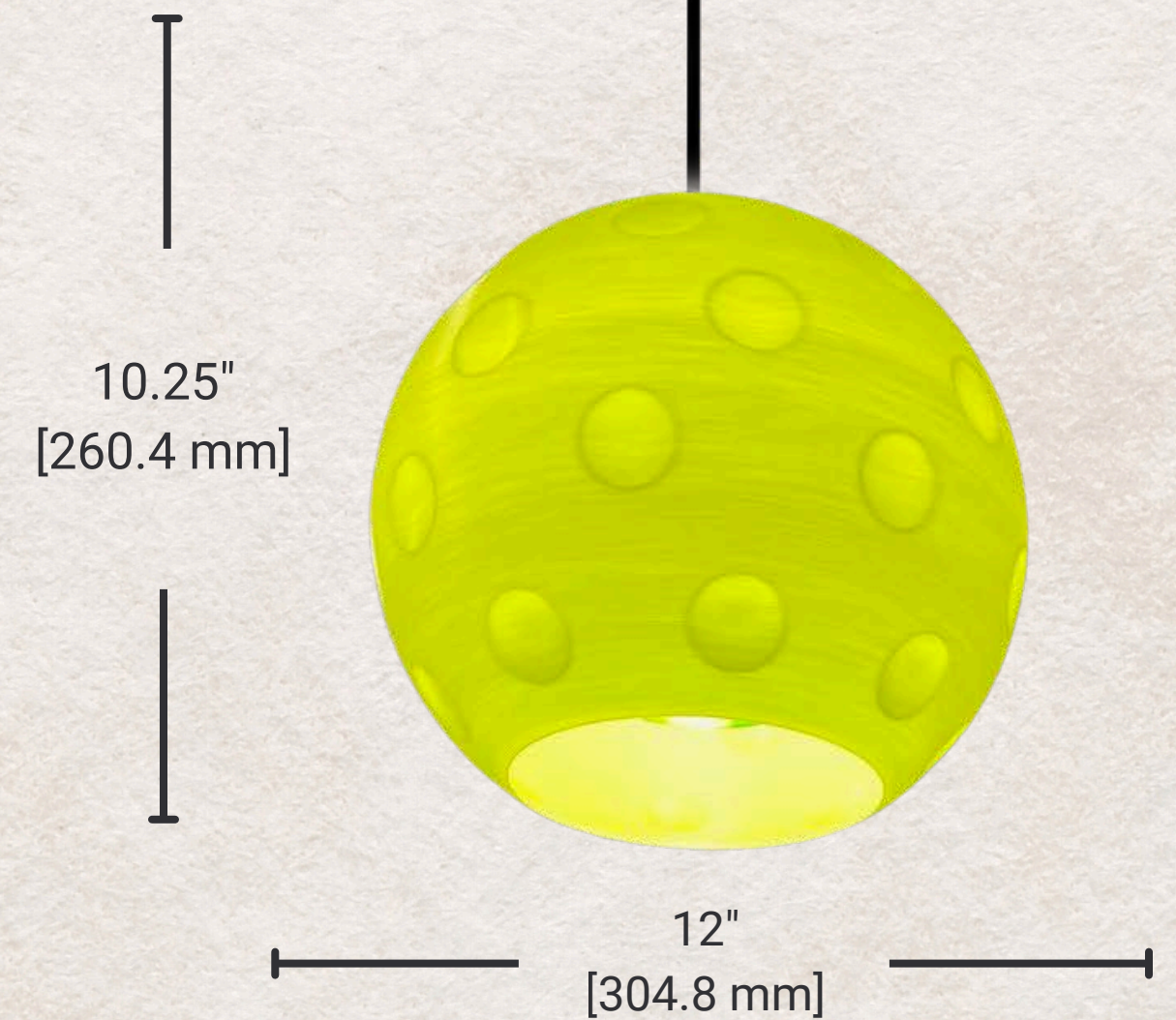

# PrentaLux | Pickleball 603

As a new build, Pickleball 603 sought lighting to enhance every area of the high-end club, from the six outdoor tournament-sized courts to the restaurant and pro shop. With PrentaLux's **personalization opportunities**, the team was able to design and print luminaires in the shape of large pickleballs. These stunning, sustainable luminaires now serve not only as a practical lighting solution but also a popular conversation piece in the restaurant and pro shop.

# PrentaLux | Pickleball 603



[Scan or click here to view the case study](#)



# How we make it work?



- We build on proven product architectures, allowing fast adaptation without starting from scratch



- We scale production from one to hundreds, depending on your needs



- We print locally to accelerate lead times and reduce waste



- We partner closely with clients - from sketch to sample to site delivery



# PrentaLux

Product Look Book | 3D Printed Luminaires

BR53105826EN April 6, 2026 10:40 AM