

## DESCRIPTION

The HBI series is an outstanding solution for high mounting height industrial or retail applications. The HBI optic has been optimized to provide maximum performance from T5 lamps. Optional uplight component is provided to enable excellent ceiling uniformity. HBI's high lumen package allows the benefits of fluorescent to be applied at high mounting heights that were traditionally exclusive to HID. The primary benefits include exceptional color rendering, high system efficacy, 95% lumen maintenance, long lamp life, instant on/instant re-strike, economical dimming, and uniform brightness control. Primary applications include retail, shopping malls, light industrial, gymnasiums and recreational environments.

## SPECIFICATION FEATURES

### Construction

Full bodied steel housing with integral ballast channel adds strength, rigidity and structural protection for optical assembly.

### Electrical

The HBI comes standard with a high ambient Class P electronic ballast and twistlock lampholders. UL/cUL listed for high ambient environments up to 65°C (149°F) for all lamps and ballast combinations when used in open upright configurations. Suitable for damp locations. Optional modular power receptacle meets UL2459 and NEC 410.73 and is UL/cUL rated for make and break under load from outside the luminaire to speed maintenance.

### Finish

White enamel finish preceded by a multistage cleaning cycle, iron phosphate coating with rust inhibitor to protect against contaminants and oxidation.

### Downlight/Uplight Optics

Die-formed, segmented optical design optimizes performance across three distributions. Optical choices include a narrow distribution for aisles, medium distribution for assembly and loading areas, or wide distribution for general, open area lighting. An uplight option is offered to permit ceiling uniformity and allow for ample lamp and luminaire heat dissipation. Gasketed door frame & lens assembly is optional for more demanding environments.

Catalog #

Project

Comments

Prepared by

Type

Date

### Options

Integral Occupancy Sensor available and provides from 600 sq. ft. (MS) up to 1250 sq. ft. (MSO) of coverage at a maximum mounting height of 40' using interchangeable lens caps provided.

### Mounting

The HBI series is suited for suspension mounting with optional wire hook and chain set or cable mounting. Single monopoint mounting is available with SPM Tong Hanger. Includes V Hangers for rapid installation.

### Warranty

When operated in high ambient conditions, the HBI is supported by a 5 yr/55°C and 3 yr/65°C ballast warranty when used with a high ambient ballast in open, upright configurations (T5HO lamping only).



## HBI SERIES

### 6 T5HO LAMPS

High-Bay Industrial  
Fluorescent Luminaire



## ENERGY DATA

Input Watts:  
**ER Ballast**  
628 = 189W  
654 = 351W

Luminaire Efficacy Rating  
LER = FL-78 (Narrow Beam)  
Catalog Number: HBI-654T5-N-UPL

### Yearly Cost of 1000 lumens,

3000 hrs. at .08 KWH = \$3.07

\* Reference the lamp/ballast data in the

Technical Section for specific lamp/ballast

requirements

\*\* Consult Pre Sales Technical Support.

\*Reference the lamp/ballast data in the Technical Section for specific lamp/ballast requirements.

\*\*Consult Pre Sales Technical Support.

LAMPS CONTAIN MERCURY. DISPOSE ACCORDING TO LOCAL, STATE OR FEDERAL LAWS

**LINEAR DISCONNECT**

Safe and convenient means of disconnecting power.



ADF091042  
June 18, 2018 10:06 AM

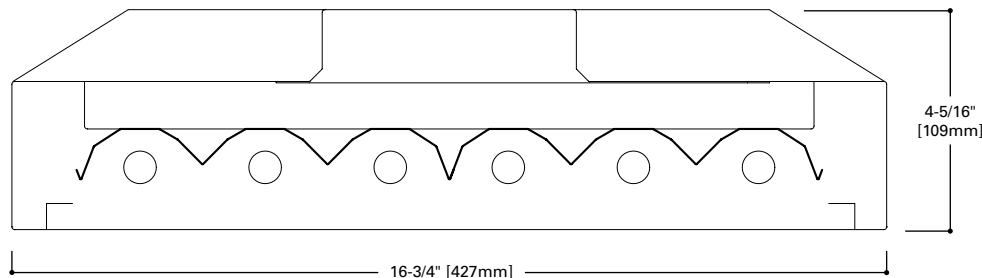

## LAMP CONFIGURATIONS

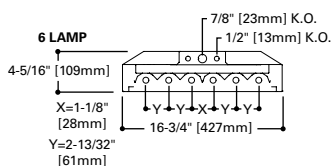

## DIMENSION TOP VIEW

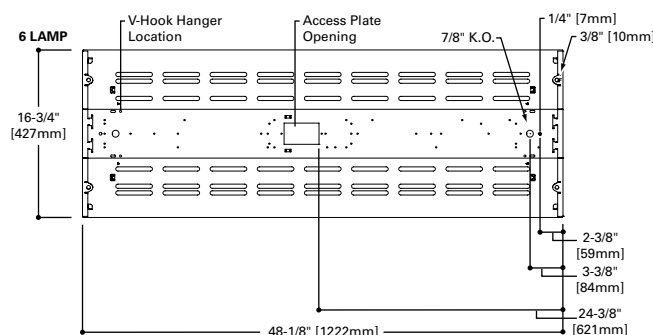

PHOTOMETRICS

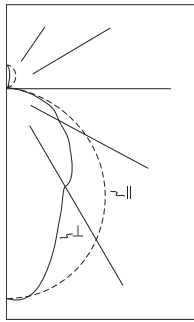

**HBI-654T5-N-UNV-EHT2-UPL**  
 (2) Electronic Ballasts  
 (6) F54T5 54W Lamps  
 3500 lumens  
 Spacing criterion:  
 (H) 1.2 x mounting height, (L) 0.9 x mounting height  
 Efficiency 93.3%  
 Test Report:  
 HBI654T5-UPL.IES  
 LER =FL-78  
 Yearly Cost of 1000 lumens, 3000 hrs at .08 KWH = \$3.07

Angle	Along H	45°	Across L
0	10966	10966	10966
5	10911	10991	10971
10	10772	10668	10272
15	10522	9899	9049
20	10184	8864	7762
25	9744	7757	6758
30	9218	6744	5989
35	8601	5860	5790
40	7923	5216	5278
45	7185	4862	4668
50	6381	4278	4184
55	5515	3633	3497
60	4592	3093	3034
65	3633	2415	2693
70	2665	1995	2053
75	1730	1480	1418
80	878	828	725
85	223	274	105
90	10	15	12

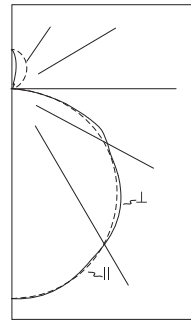

**HBI-654T5-W-UNV-EHT2-UPL**  
 (2) Electronic Ballasts  
 (6) F54T5 54W Lamps  
 4400 lumens  
 Spacing criterion:  
 (H) 1.3 x mounting height, (L) 1.3 x mounting height  
 Efficiency 92.6%  
 Test Report:  
 HBI654-W-UPL.IES  
 LER =FL-78  
 Yearly Cost of 1000 lumens, 3000 hrs at .08 KWH = \$3.09

Angle	Along H	45°	Across L
0	7332	7332	7332
5	7301	7321	7337
10	7231	7258	7265
15	7096	7125	7111
20	6913	6918	6872
25	6671	6634	6601
30	6377	6302	6377
35	6033	5963	6148
40	5651	5632	5832
45	5230	5278	5420
50	4776	4845	4929
55	4282	4331	4338
60	3747	3754	3898
65	3159	3113	3517
70	2512	2647	2750
75	1820	2005	1927
80	1079	1174	1029
85	346	400	183
90	14	40	36

Coefficients of Utilization

rc	Effective floor cavity reflectance																	
	80%			70%			20%											
rw	70	50	30	70	50	30	10	0										
0	110	110	110	107	107	107	101	101	101	96	96	96	91	91	91	89		
1	101	97	93	90	98	94	91	88	90	87	84	85	83	81	81	80	78	76
2	92	85	79	74	90	83	77	73	79	74	70	75	72	68	72	69	66	64
3	85	75	68	62	82	73	67	61	70	64	60	67	62	58	64	60	57	54
4	78	67	59	53	75	65	58	53	63	56	51	60	55	50	58	53	49	47
5	72	60	52	46	69	59	51	46	56	50	45	54	49	44	52	47	43	41
6	66	54	46	41	64	53	46	40	51	45	40	49	43	39	48	42	38	36
7	62	50	42	36	60	49	41	36	47	40	35	45	39	35	44	38	34	32
8	58	45	38	33	56	45	37	32	43	37	32	42	36	31	40	35	31	29
9	54	42	34	29	52	41	34	29	40	33	29	39	33	29	37	32	28	27
10	51	39	32	27	49	38	31	27	37	31	26	36	30	26	35	30	26	24

Coefficients of Utilization

rc	Effective floor cavity reflectance																	
	80%			70%			20%											
rw	70	50	30	70	50	30	10	0										
0	109	109	109	106	106	106	100	100	100	95	95	95	90	90	90	87		
1	99	94	90	87	96	92	88	85	87	84	81	82	80	78	78	76	74	72
2	90	82	75	70	87	80	74	68	75	70	66	72	67	64	68	65	62	59
3	81	71	64	57	79	69	62	56	66	60	55	63	57	53	60	55	52	49
4	74	63	54	48	72	61	53	47	58	52	46	55	50	45	53	48	44	42
5	68	56	47	41	66	55	47	41	52	45	40	50	44	39	47	42	38	36
6	63	50	42	36	61	49	41	35	47	40	35	45	39	34	43	37	33	31
7	58	45	37	31	56	44	37	31	42	35	30	41	34	30	39	33	29	27
8	54	41	33	28	52	40	33	28	39	32	27	37	31	27	36	30	26	24
9	50	38	30	25	49	37	30	25	36	29	24	34	28	24	33	27	23	22
10	47	35	27	22	46	34	27	22	33	26	22	32	26	22	31	25	21	20

Zonal Lumen Summary

Zone	Lumens	%Lamp	%Fixture
0-30	7518	28.5	30.5
0-40	11618	44.0	47.1
0-60	19142	72.5	77.7
0-90	23554	89.2	95.6
0-180	24650	93.3	100.0

Luminance Data

Angle in Deg	Average 0-Deg cd/sm	Average 45-Deg cd/sm	Average 90-Deg cd/sm
45	23633	15992	15354
55	22363	14732	14180
65	19994	13291	14821
75	15546	13300	12743
85	5951	7312	2802

Zonal Lumen Summary

Zone	Lumens	%Lamp	%Fixture
0-30	5773	21.9	23.6
0-40	9557	36.2	39.1
0-60	17462	66.1	71.4
0-90	23082	87.4	94.4
0-180	24447	92.6	100.0

Luminance Data

Angle in Deg	Average 0-Deg cd/sm	Average 45-Deg cd/sm	Average 90-Deg cd/sm
45	14044	14173	14555
55	14176	14338	14361
65	14193	13987	15802
75	13352	14710	14137
85	7538	8715	3987

Modular F-Bay Power Supply Option

Cooper Lighting Solutions' F-Bay Modular Power Supply option is available for use with all F-Bay products. The modular power supply allows external fixture access for safe and easy servicing. There is no need to remove lamps or reflectors to disconnect fixture power with F-Bay Modular Power Supply. Access to the individual fixtures power supply allows servicing without turning off all the fixtures, disrupting occupants. F-Bay Modular Power Supply is a time-saver in installation **—simply plug & power.**



1. Modular Power Supply Receptacle supplied mounted into fixture Access Plate
2. Modular Power Cord & Plugs in 120, 277, 347, & 480V configurations for easy plug & power into existing supply

No internal fixture access required for installation or disconnecting power

Modular Motion Sensor Option supplied with Mounting Box and Modular Power Supply Receptacle

Code Compliance

- UL/cUL Certified for Make/Break under load (UL2549)
- Meets NEC requirements for ballast disconnect (NEC 410.73G)
- Allows for addition of Occupancy Sensor without hard connections
- Receptacles complete with insulating/dust cap

**ORDERING INFORMATION**

**SAMPLE NUMBER:** HBI-654T5-A-UNV-EHT2-MP-UPL-U **Includes V Hangers for rapid installation<sup>(6)</sup>**

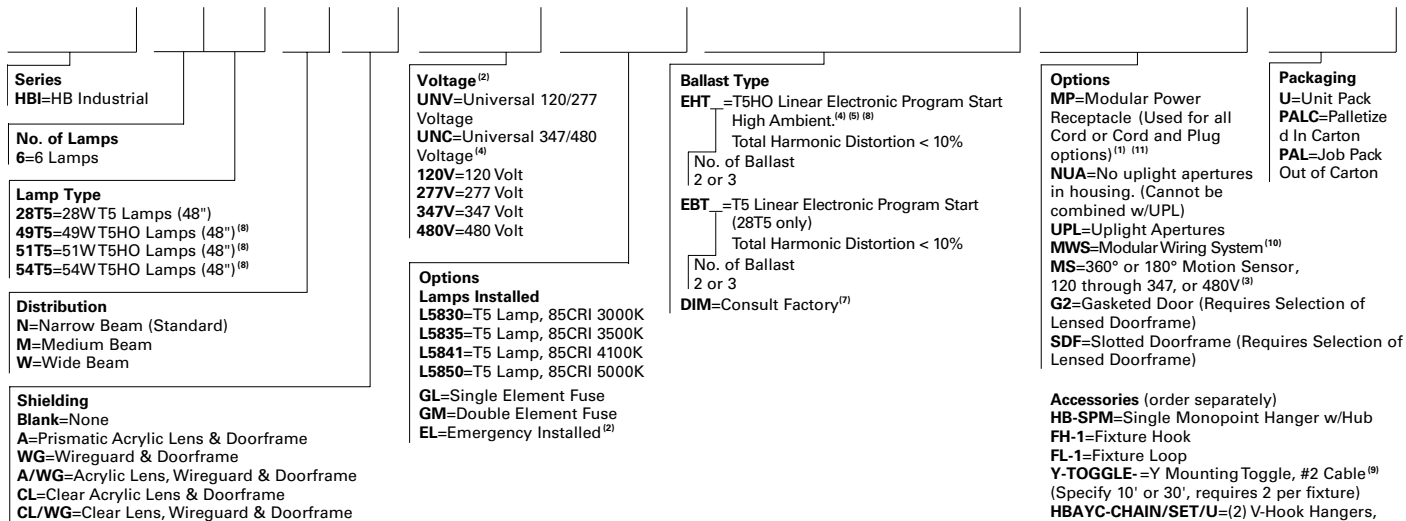

**NOTES:** <sup>(1)</sup>Requires use of MC\_ or MPC\_cord accessories, specify voltage for plugs. <sup>(2)</sup>Voltage must be specified when ordered with plugs or emergency ballasts. <sup>(3)</sup>When ordering MS option, specify voltage as UNV (for 120 or 277V), 347 or 480V. <sup>(4)</sup>2 lamp ballast configurations only for T5 UNC versions. <sup>(5)</sup>EHT/HT5/HCT5 ballast systems suitable for ambient environments not to exceed 149°F (65°C) in open upright configurations and less lens option. <sup>(6)</sup>Can be used in high abuse applications such as gymnasiums. <sup>(7)</sup>Dimming ballast must be specified at time of order. <sup>(8)</sup>EHT standard with T5HO lamps. <sup>(9)</sup>two required. <sup>(10)</sup>Cannot be combined with Modular Power Receptacle (MP). <sup>(11)</sup>For MWS with MP, choose MP in fixture logic and then choose MWS accessory such as MDS6.

Specifications & dimensions subject to change without notice. Consult your Cooper Lighting Solutions Representative for availability and ordering information.



**Quick Ship Ordering Information** Sample Number: HBI654HCT5-MP-UPL-L5

Quick Ship orders ship in 5 days in order quantities not to exceed 200 pieces.

**NOTE:** Orders received after noon are entered on the following day.

**Includes V Hangers for rapid installation<sup>(6)</sup>**

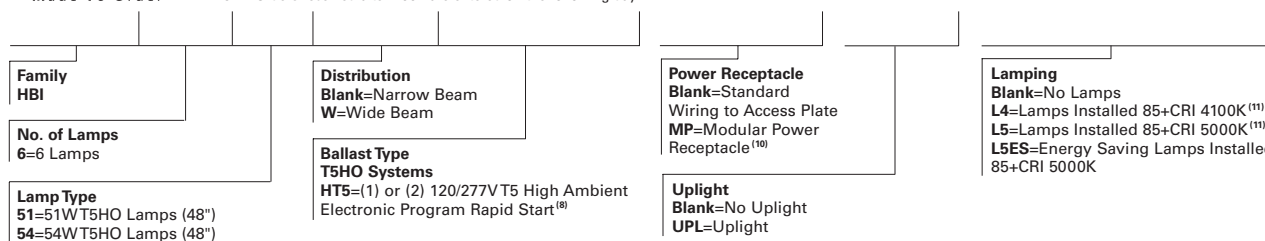

**NOTES:** <sup>(10)</sup>Requires use of Modular cord and plug accessories. <sup>(11)</sup>For Quick Ship, lamping option only available w/54W lamp type.

**SHIPPING DATA**

HBI-654T5-UPL 16 lbs.