

Project		Catalog #		Type	
Prepared by		Notes		Date	



# HALO

## RL56 | Selectable CCT

5-inch/6-inch All-purpose LED retrofit module with SeleCCTable switch

### Typical Applications

Residential

### Interactive Menu

- Order Information page 2
- Product Specifications page 3
- Photometric Data page 4
- Energy & Performance Data page 4
- Product Warranty
- Dimming Guide

### Product Certification



Refer to ENERGY STAR® Certified Products List.  
Can be used to comply with California Title 24 High Efficacy requirements.  
Certified to California Appliance Efficiency Database under JAB.

**Note:** Due to T20 change, as of July 1, 2019 consult factory on correct catalog number and availability for T20 compliant California product.

### Product Features



### Top Product Features

- Select from 5 CCTs via switch; 2700K, 3000K, 3500K, 4000K, 5000K CCT; 90 CRI
- Lumens: 600, 900, 1200
- Use with 5" or 6" housings with screwbase adapter included
- Dimmable down to 5%
- Dual-mount: Torsion Spring and Push-N-Twist clip models

### Dimensional and Mounting Details

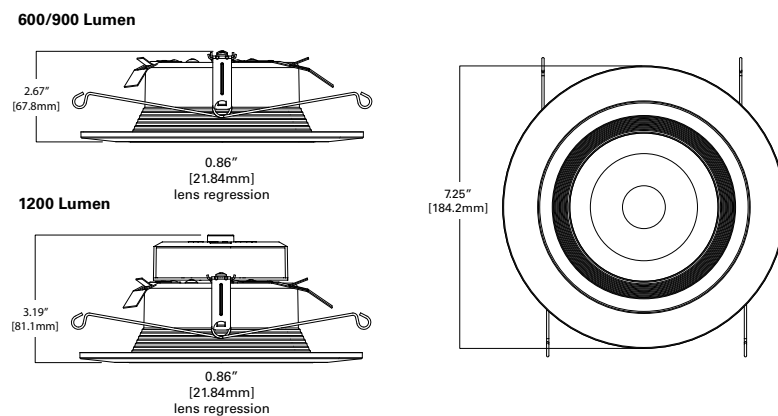

### Scale

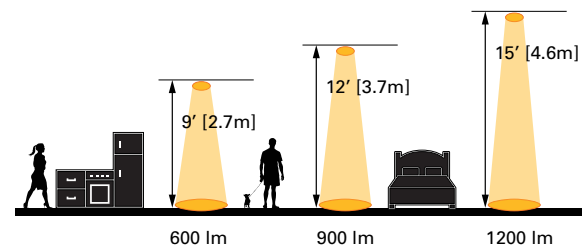

## Order Information\*

SAMPLE ORDER NUMBER: **RL56069S1EWHR**

Models	Lumens	CRI/CCT	Driver	Finish	Packaging	T20 Compliant
<b>RL56</b> = 5"/6" all-purpose retrofit LED module	<b>06</b> = 600 lumens (nominal) <b>09</b> = 900 lumens (nominal) <b>12</b> = 1200 lumens (nominal)	<b>9S</b> = 90 CRI minimum, white tuning, selectable CCT 2700K-5000K	<b>1E</b> = 120V 60Hz leading or trailing edge phase cut 1% dimming	<b>WH</b> = Matte white baffle	<b>R</b> = Recyclable	<b>-CA</b>
<b>Notes</b>	<b>Notes</b>	<b>Notes</b>	<b>Notes</b>	<b>Notes</b>	<b>Notes</b>	<b>Notes</b>

### Accessories

Accessories
<p><b>Designer Trims</b></p> <p><b>RL56TRMWHB</b> = 5"/6" decorative overlay, white paintable, Baffle  <b>RL56TRMMBB</b> = 5"/6" decorative overlay, matte black, Baffle  <b>RL56TRMSNB</b> = 5"/6" decorative overlay, satin nickel, Baffle  <b>RL56TRMTBZB</b> = 5"/6" decorative overlay, tuscan bronze, Baffle</p> <p><b>RL56TRMWH</b> = 5"/6" decorative overlay, white paintable, trim ring  <b>RL56TRMMB</b> = 5"/6" decorative overlay, matte black, trim ring  <b>RL56TRMSN</b> = 5"/6" decorative overlay, satin nickel, trim ring  <b>RL56TRMTBZ</b> = 5"/6" decorative overlay, tuscan bronze, trim ring</p>
<b>Notes</b>



**RL56TRMWHB**  
White (Paintable), Baffle

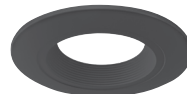

**RL56TRMMBB**  
Matte Black, Baffle

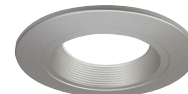

**RL56TRMSNB**  
Satin Nickel, Baffle

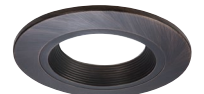

**RL56TRMTBZB**  
Tuscan Bronze, Baffle



**RL56TRMWH**  
White (Paintable), Splay



**RL56TRMMB**  
Matte Black, Splay



**RL56TRMSN**  
Satin Nickel, Splay

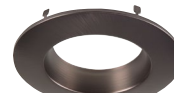

**RL56TRMTBZ**  
Tuscan Bronze, Splay

### Housings

Housings	
<p><b>Halo LED 5-inch</b></p> <p><b>H550ICAT</b> = 5" LED, Insulated Ceiling, Air-Tite, New Construction Housing  <b>H550RICAT</b> = 5" LED, Insulated Ceiling, Air-Tite, Remodel Housing  <b>E550ICAT</b> = 5" LED, Insulated Ceiling, Air-Tite, New Construction Housing  <b>E550RICAT</b> = 5" LED, Insulated Ceiling, Air-Tite, Remodel Housing</p> <p><b>Halo LED 6-inch</b></p> <p><b>H750ICAT</b> = 6" LED, Insulated Ceiling, Air-Tite, New Construction Housing  <b>H750RICAT</b> = 6" LED, Insulated Ceiling, Air-Tite, Remodel Housing  <b>H750T</b> = 6" LED, Non-IC, Air-Tite, New Construction Housing  <b>H750TCP</b> = 6" LED, Non-IC, New Construction/Remodel Chicago Plenum Housing  <b>H2750ICAT</b> = 6" LED, Shallow, Insulated Ceiling, Air-Tite, New Construction (use with 691X, 694X, 696X trims only)  <b>H2750RICAT</b> = 6" LED, Shallow, Insulated Ceiling, Air-Tite, Remodel (use with 691X, 694X, 696X trims only)  <b>E750ICAT</b> = 6" LED, Insulated Ceiling, Air-Tite, New Construction Housing  <b>E750RICAT</b> = 6" LED, Insulated Ceiling, Air-Tite, Remodel Housing</p> <p><b>Halo LED retrofit</b></p> <p><b>ML7E26RFK</b> = 6" Retrofit Enclosure, Non-IC, E26 Screw base Interface  <b>ML7BXFK</b> = 6" Retrofit Enclosure, Non-IC, BX Whip</p> <p><b>Halo Shallow Housings 5-inch</b></p> <p><b>H25ICAT</b> = 5" Shallow, Insulated Ceiling, Air-Tite New Construction  <b>H25RICAT</b> = 5" Shallow, Insulated Ceiling, Air-Tite Remodel  <b>H25ICATNB</b> = 5" Shallow, Insulated Ceiling, Air-Tite New Construction, No Socket Bracket</p> <p><b>Halo Shallow Housings 6-inch</b></p> <p><b>H27ICAT</b> = 6" Shallow, Insulated Ceiling, Air-Tite New Construction  <b>H27RICAT</b> = 6" Shallow, Insulated Ceiling, Air-Tite Remodel Housing  <b>H27T</b> = 6" Shallow, Non-IC, New Construction Housing  <b>H27RT</b> = 6" Shallow, Non-IC, Remodel Housing  <b>E27ICAT</b> = 6" Shallow, Insulated Ceiling, Air-Tite New Construction  <b>E27RICAT</b> = 6" Shallow, Insulated Ceiling, Air-Tite Remodel Housing  <b>E27TAT</b> = 6" Shallow, Non-IC, New Construction Housing  <b>E27RTAT</b> = 6" Shallow, Non-IC, Remodel Housing</p>	<p><b>Halo Standard Housings 5-inch</b></p> <p><b>H5ICAT</b> = 5" Insulated Ceiling, Air-Tite New Construction Housing  <b>H5RICAT</b> = 5" Insulated Ceiling, Air-Tite Remodel Housing  <b>H5ICATNB</b> = 5" Insulated Ceiling, Air-Tite New Construction Housing, No Socket Bracket  <b>H5T</b> = 5" Non-IC, New Construction Housing  <b>H5RT</b> = 5" Non-IC, Remodel Housing  <b>H5TNB</b> = 5" Non-IC, New Construction Housing, No Socket Bracket  <b>E5ICAT</b> = 5" Insulated Ceiling, Air-Tite New Construction Housing  <b>E5RICAT</b> = 5" Insulated Ceiling, Air-Tite Remodel Housing  <b>E5ICATNB</b> = 5" Insulated Ceiling, Air-Tite New Construction Housing, No Socket Bracket  <b>E5TAT</b> = 5" Non-IC, New Construction Housing  <b>E5RTAT</b> = 5" Non-IC, Remodel Housing  <b>E5TATNB</b> = 5" Non-IC, New Construction Housing, No Socket Bracket</p> <p><b>Halo Standard Housings 6-inch</b></p> <p><b>H7ICAT</b> = 6" Insulated Ceiling, Air-Tite New Construction Housing  <b>H7RICAT</b> = 6" Insulated Ceiling, Air-Tite Remodel Housing  <b>H7ICT</b> = 6" Insulated Ceiling, New Construction Housing  <b>H7RICT</b> = 6" Insulated Ceiling, Remodel Housing  <b>H7ICATNB</b> = 6" Insulated Ceiling, Air-Tite New Construction Housing, No Socket Bracket  <b>H7ICTNB</b> = 6" Insulated Ceiling, New Construction Housing, No Socket Bracket  <b>H7T</b> = 6" Non-IC, New Construction Housing  <b>H7RT</b> = 6" Non-IC, Remodel Housing  <b>H7TNB</b> = 6" Non-IC, New Construction Housing, No Socket Bracket  <b>H7TCP</b> = 6" Non-IC, Chicago Plenum, New Construction/Remodel Housing  <b>H7UICAT</b> = 6" Insulated Ceiling, Universal, Air-Tite, New Construction Housing  <b>E7ICAT</b> = 6" Insulated Ceiling, Air-Tite New Construction Housing  <b>E7RICAT</b> = 6" Insulated Ceiling, Air-Tite Remodel Housing  <b>E7ICATNB</b> = 6" Insulated Ceiling, Air-Tite New Construction Housing, No Socket Bracket  <b>E7TAT</b> = 6" Non-IC, New Construction Housing  <b>E7RTAT</b> = 6" Non-IC, Remodel Housing  <b>E7TATNB</b> = 6" Non-IC, New Construction Housing, No Socket Bracket</p>
<b>Notes</b>	

## Product Specifications

### CCT Select System

- Use the switch to choose between 2700K, 3000K, 3500K, 4000K, and 5000K CCT.

### Module - Trim

- Module construction includes LED array, heat sink, reflector, lens, baffle and trim ring.
- Regressed baffle
- Heat sink designed to conduct heat away from the LED array, keeping the junction temperatures below specified maximums, even when installed in insulated ceiling environments.

### LED Array

- Mid power LED array provides a uniform source with high efficiency and no pixilation.
- 90 CRI minimum, R9 greater than 50
- Color accuracy at 4 SDCM in between endpoints, provide color accuracy and uniformity.
- Color Temperature (CCT) has a selectable range from 2700K to 5000K (factory default 3000K)

### Optical Assembly

- Regressed lens
- Impact-resistant polycarbonate
- Convex form and lamp-like appearance
- Diffuse for even illumination

### Driver

- Integral 120V 60 Hz constant current driver provides noise free operation
- Continuous, flicker-free dimming from 100% to 5%.
- Inline electrical quick connect and E26 adapter (provided) provides mains connections
- See Dimming Guide for compatible dimmers

### Retention

- Integral torsion springs and Push-N-Twist clips offer two mounting options
- Torsion springs are pre-installed and adjust to fit 5" or 6" compatible housings
- Push-N-Twist universal installation clips are pre-installed and designed to fit 5" or 6" compatible housings

### Designer Skins (sold separately)

- RL56 skins are accessory rings that attach to the RL56 for a permanent finish. Refer to the RL56 accessories specification sheet for details.
  - White (Paintable)
  - Satin Nickel
  - Tuscan Bronze

### Gaskets

- Closed cell gaskets achieve restrictive airflow requirements without additional caulking

### Compliance

- UL Certified
- Wet and Damp location listed.
- Airtight certified per ASTM-E283
- Suitable for use in clothes closets when installed in accordance with the NEC 410.16 spacing requirements
- EMI/RFI emissions per FCC 47CFR Part 15 consumer limits
- Contains no mercury or lead and RoHS compliant
- Photometric testing in accordance with IES LM-79-08
- Lumen maintenance projections in accordance with IES LM-80-08 and TM-21-11
- Can be used for State of California Title 24 high efficacy luminaire compliance. Complies with Title 24 JA8-2016-E.
- Can be used International Energy Conservation Code (IECC) high efficiency luminaire compliance.
- ENERGY STAR® listed, reference database for current listings

### Warranty

- Five year limited warranty, consult website for details. [www.cooperlighting.com/warranty](http://www.cooperlighting.com/warranty)

## Photometric Data

View IES files

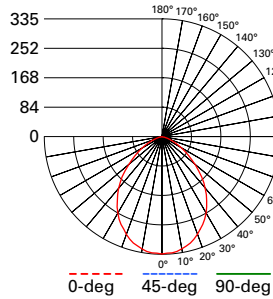

### RL56069S1EWHR-3000K

Spacing criterion: (0-180) 1.14  
(90-270) 1.14  
(Diagonal) 1.22

Beam Angle: 87.8°  
Field Angle: 139°  
Lumens: 693  
Input Watts: 7.9 W  
Efficacy: 87.7 LPW  
Test Report:  
RL56069S1EWHR-3000K.ies

Zonal Lumen	Lumens	% Lumens
0-30	247	37.2
0-40	387	58.2
0-60	595	89.4
0-90	665	100

TM-30-15	Rf = 89.8
	Rg = 98
CRI/CIE	Ra = 93.7
	R9 = 69.1

CCT - Range of 2700K- 5000K



93°

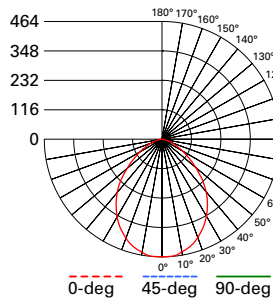

### RL56099S1EWHR-3000K

Spacing criterion: (0-180) 1.16  
(90-270) 1.16  
(Diagonal) 1.22

Beam Angle: 88.9°  
Field Angle: 140°  
Lumens: 957  
Input Watts: 11.5 W  
Efficacy: 83.2 LPW  
Test Report:  
RL56099S1EWHR-3000K.ies

Zonal Lumen	Lumens	% Lumens
0-30	345	36.7
0-40	541	57.5
0-60	838	89.1
0-90	940	100

TM-30-15	Rf = 89.8
	Rg = 97.7
CRI/CIE	Ra = 93.1
	R9 = 64.6

CCT - Range of 2700K- 5000K



93°

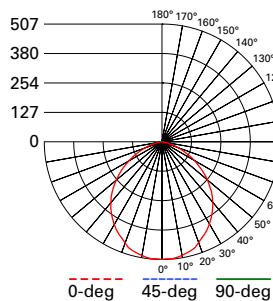

### RL56129S1EWHR-3000K

Spacing criterion: (0-180) 1.21  
(90-270) 1.21  
(Diagonal) 1.31

Beam Angle: 93°  
Field Angle: 140°  
Lumens: 1399  
Input Watts: 14.2 W  
Efficacy: 91.5 LPW  
Test Report:  
RL56129S1EWHR-3000K.ies

Zonal Lumen	Lumens	% Lumens
0-30	345	31.7
0-40	541	51.5
0-60	838	85.5
0-90	940	100

TM-30-15	Rf = 89.8
	Rg = 97.7
CRI/CIE	Ra = 93.1
	R9 = 64.6

CCT - Range of 2700K- 5000K



93°

## Energy and Performance Data

RL56069S1EWHR	
Max. Lumens	736 @ 5000K
Input Voltage	120V
Input Frequency	50/60 Hz
Input Power	7.9W
Input Current	0.15 A
Power Factor	>0.90
THD	<20%
EMI/RFI	FCC Title 47 CFR, Part 15, Class B (Consumer)
Sound Rating	Class A
Minimum Starting Temp	-30°C (-22°F)

RL56099S1EWHR	
Max. Lumens	1012 @ 5000K
Input Voltage	120V
Input Frequency	50/60 Hz
Input Power	11.4W
Input Current	0.15 A
Power Factor	>0.90
THD	<20%
EMI/RFI	FCC Title 47 CFR, Part 15, Class B (Consumer)
Sound Rating	Class A
Minimum Starting Temp	-30°C (-22°F)

RL56129S1EWHR	
Max. Lumens	1399 @ 5000K
Input Voltage	120V
Input Frequency	50/60 Hz
Input Power	14.1W
Input Current	0.15 A
Power Factor	>0.90
THD	<20%
EMI/RFI	FCC Title 47 CFR, Part 15, Class B (Consumer)
Sound Rating	Class A
Minimum Starting Temp	-30°C (-22°F)

Tested in accordance with IES LM63. Field results may vary.

Note: Refer to IES files for more product data.

## Photometric Data

View IES files

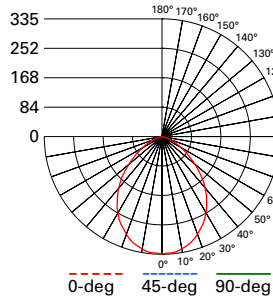

**RL56069S1EWHR-CA-3000K**  
 Spacing criterion: (0-180) 1.14  
 (90-270) 1.14  
 (Diagonal) 1.22  
 Beam Angle: 87.8°  
 Field Angle: 139°  
 Lumens: 665  
 Input Watts: 7.6 W  
 Efficacy: 87.5 LPW  
 Test Report:  
 RL56069S1EWHR-CA-3000K.ies

Zonal Lumen	Lumens	% Lumens
0-30	247	37.2
0-40	387	58.2
0-60	595	89.4
0-90	665	100

TM-30-15	Rf = 89.8
	Rg = 98
CRI/CIE	Ra = 93.7
	R9 = 69.1

CCT - Range of 2700K- 5000K



93°

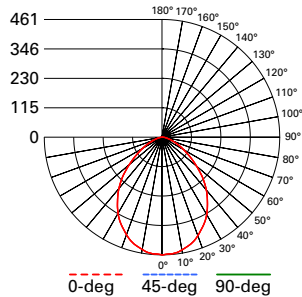

**RL56099S1EWHR-CA-3000K**  
 Spacing criterion: (0-180) 1.13  
 (90-270) 1.13  
 (Diagonal) 1.21  
 Beam Angle: 88.9°  
 Field Angle: 140°  
 Lumens: 923  
 Input Watts: 9.9 W  
 Efficacy: 93.1 LPW  
 Test Report:  
 RL56099S1EWHR-CA-3000K.ies

Zonal Lumen	Lumens	% Lumens
0-30	343	37.2
0-40	536	58.1
0-60	824	89.4
0-90	922	100

TM-30-15	Rf = 89.8
	Rg = 97.7
CRI/CIE	Ra = 93.1
	R9 = 64.6

CCT - Range of 2700K- 5000K

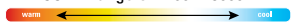

93°

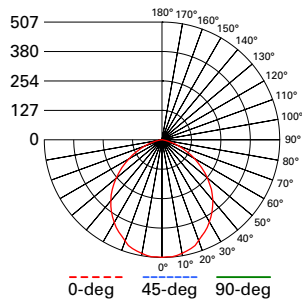

**RL56129S1EWHR-CA-3000K**  
 Spacing criterion: (0-180) 1.21  
 (90-270) 1.21  
 (Diagonal) 1.31  
 Beam Angle: 93°  
 Field Angle: 140°  
 Lumens: 1221  
 Input Watts: 14 W  
 Efficacy: 87.2 LPW  
 Test Report:  
 RL56129S1EWHR-CA-3000K.ies

Zonal Lumen	Lumens	% Lumens
0-30	345	31.7
0-40	541	51.5
0-60	838	85.5
0-90	940	100

TM-30-15	Rf = 89.8
	Rg = 97.7
CRI/CIE	Ra = 93.1
	R9 = 64.6

CCT - Range of 2700K- 5000K



93°

## Energy and Performance Data

RL56069S1EWHR-CA	
Max. Lumens	712 @ 4000K
Input Voltage	120V
Input Frequency	50/60 Hz
Input Power	7.6W
Input Current	0.15 A
Power Factor	>0.90
THD	<20%
EMI/RFI	FCC Title 47 CFR, Part 15, Class B (Consumer)
Sound Rating	Class A
Minimum Starting Temp	-30°C (-22°F)

RL56099S1EWHR-CA	
Max. Lumens	946 @ 4000K
Input Voltage	120V
Input Frequency	50/60 Hz
Input Power	9.9W
Input Current	0.15 A
Power Factor	>0.90
THD	<20%
EMI/RFI	FCC Title 47 CFR, Part 15, Class B (Consumer)
Sound Rating	Class A
Minimum Starting Temp	-30°C (-22°F)

RL56129S1EWHR-CA	
Max. Lumens	1272 @ 5000K
Input Voltage	120V
Input Frequency	50/60 Hz
Input Power	14W
Input Current	0.15 A
Power Factor	>0.90
THD	<20%
EMI/RFI	FCC Title 47 CFR, Part 15, Class B (Consumer)
Sound Rating	Class A
Minimum Starting Temp	-30°C (-22°F)