

DESCRIPTION

The HALO WP11 series LED wall pack is a dependable security lighting solution designed to replace compact wall packs which use fluorescent or traditional light sources. The integrated dusk to dawn photocontrol allows for nighttime ON and daytime OFF operation, while the impact resistant polycarbonate housing ensures years of reliable operation. Ideal for multi-family, light commercial and wall mounted lighting in public areas.

Catalog #		Type
Project		
Comments		Date
Prepared by		

SPECIFICATION FEATURES

Construction

- High impact, weather resistant housing and lens
- Available in bronze finish
- Mounts to standard recessed junction boxes

Electrical

- Maintenance-free LEDs with 50,000 hours of life
- Fixture operating temperature range from -20°C to 40°C
- 12,000 cycle rated integral photocontrol included
- Electrical operating voltage 120VAC 60Hz
- cULus listed for Wet locations

Optical

- Fixture produces up to 1220 lumens, equivalent light output up to 26W CFL
- Available in 3500K and 5000K CCT

Warranty

5 year limited warranty



WP11 SERIES LED WALL PACK

DIMENSIONS

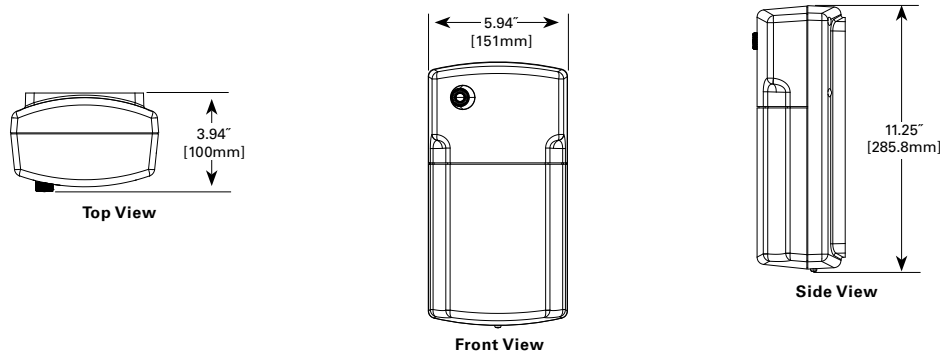

ORDERING INFORMATION

Model	CCT	Finish
WP1135LPC	3500K	Bronze
WP1150LPC	5000K	Bronze

CERTIFICATION DATA

cULus Wet Location Listed

TECHNICAL DATA

120V only
-20°C to 40°C Temperature Rating
External Supply Wiring 75° Minimum

TECHNICAL INFORMATION

Model	Voltage	Power	Delivered Lumens	Efficacy Lumen/ Watt	LED Color Temperature (K)	CRI
WP1135LPC	120V	13.8	1220	90	3500K	85
WP1150LPC	120V	13.6	1180	84	5000K	85

PHOTOMETRICS

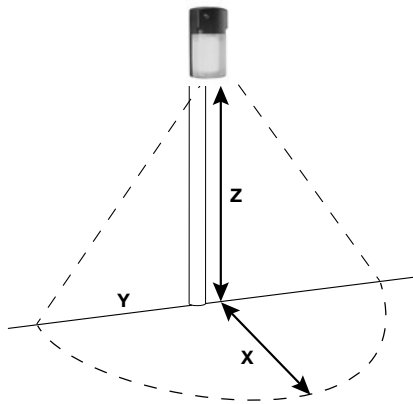

Mounting Height (Z)	Lumens	0.25 Fc Coverage Area					
		8		10		15	
Catalog Number		X	Y	X	Y	X	Y
WP1135LPC	1220	20	28	22	28	21	25
WP1150LPC	1180	20	28	21	28	20	21

X = Forward Throw
Y = Wall Spread
Z = Mounting Heights